

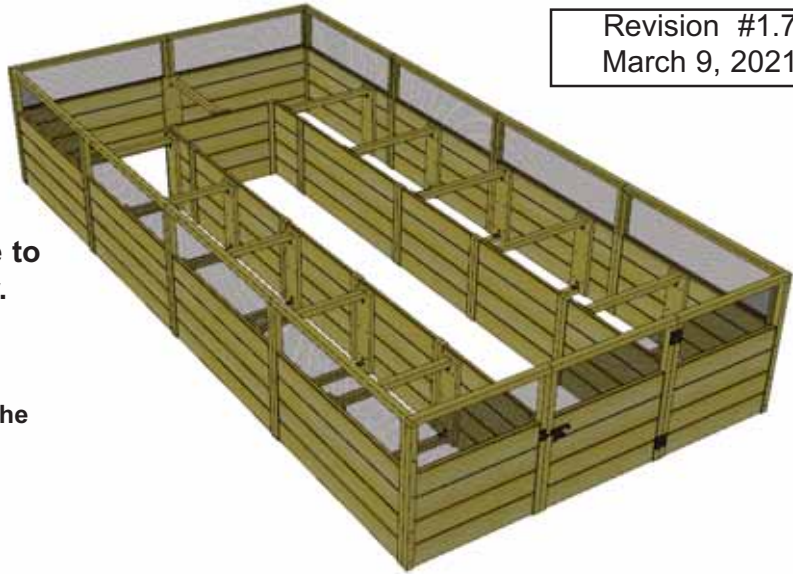

8'X16' Garden in a Box Assembly Manual

Licensed under US PATENTS 7,424,787; 7,490,435

Revision #1.7
March 9, 2021



Thank you for purchasing a 8' x 16' Garden in a Box. Please take the time to identify all the parts prior to assembly.

Safety Points and Other Considerations

Please follow this instruction manual when assembling your Garden in a Box and retain the manual for future maintenance purposes.

Please use Safety Eyewear and Gloves while Assembling. Be sure to read and follow all operating instructions for any tools used during assembly.
Remember- NO SAW CUTTING IS REQUIRED!

Garden in a Box Dimensions:

- A: Height = 33 1/2"
- B: Outside Width = 92"
- C: Outside Depth = 187"
- D: Height to Bottom of Screen = 21 1/2"
- E: Door Width = 30 5/8"
- F: Length of Inner Panel Sections = 151 1/2"

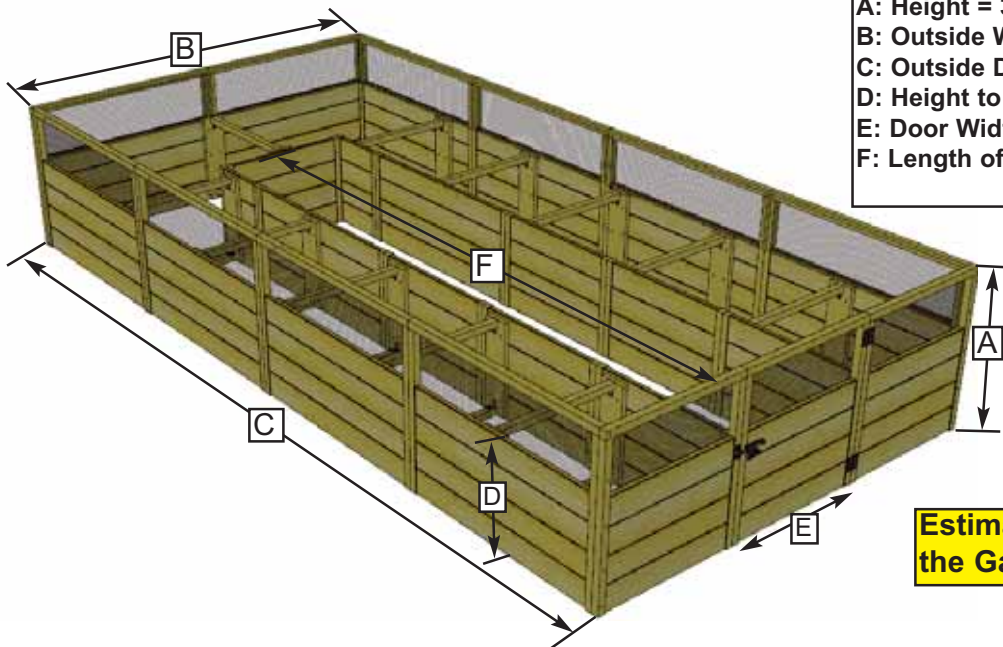

Estimated Assembly Time for the Garden in a Box = 6 Hours.

In the event of a missing or broken piece, simply call the Outdoor Living Today Customer Support Line @ 1-888-658-1658 within 30 days of the delivery of your purchase. It is our commitment to you to courier replacement parts, free of charge, within 10 business days of this notification. Replacement parts will not be provided free of charge after the 30 day grace period.

Exploded View and Parts List for 8'x16' Garden in a Box

Parts List

- Part A** 10 - Side/Rear Panels
46" wide x 33 1/2" high
- Parts B & C** 2 - Front Panels & 1 - Door Panel
30 5/8" wide x 33 1/2" high
- Part D** 7 - Interior Panels
30 5/8" wide x 22" high
- Part DD** 2 - Narrow Interior Panels
15 3/8" wide x 22" high
- Part DDD** 2 - Wide Interior Panels
46" wide x 22" high
- Part E** 22 - Bed Rib Connecting Plates
1" thick x 5 1/2" wide x 20" high
- Part F** 20 - Bed Rib Frames (sides)
1 1/2" thick x 1 1/2" wide x 26 3/8" long
- Part G** 3 - Bed Rib Frames (rear) - 1 extra
1 1/2" thick x 1 1/2" wide x 29 1/4" long
- Part H** 1 - Door Stop
3/4" thick x 1 1/2" wide x 4" long (not shown)

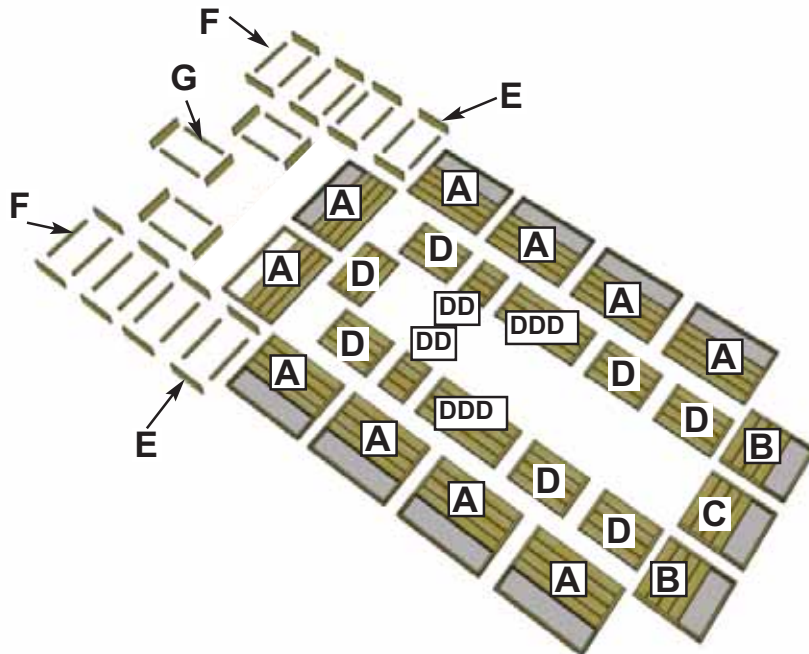

Note: There is no difference between Parts B and C until later in the assembly manual when one will be used as a Door.

Hardware Kit (Provided)

2 1/2"  x 135 pcs

2"  x 138 pcs

1"  x 180 pcs

3/4"  x 24 pcs

Black Headed Screw

 x 1 pc
Square Drive Bit



Black Barrel Bolt x 1 pc



Bracket x 44 pcs



Plastic Hinges x 2 pcs

Tools Required (Not Provided)



Screw Gun/Drill



Tape Measure



Level



Wood Clamp



Shovel



1/8" Drill Bit

Safety Equipment Required (Not Provided)



Safety Glasses



Work Gloves

To prevent soil seepage and extend the life of your garden bed, we recommend you line the inner walls with landscape fabric or plastic sheeting (not provided) before filling with soil.

Important Information for Homeowner

Selecting a Location - Garden Setting or Patio

Walk around your property and make notes of the following:

- sunny spots
- slope of the land
- light blocking trees and high buildings.

Don't hide your Garden away in a dark corner.

Ensure you have easy access to it.

Place your Garden on a level piece of land with good drainage. Take into account existing paths and utilities such as electricity and water.

Having a water supply at hand avoids carrying heavy watering cans from the tap to the garden bed.

Preparing the Ground for a Garden Setting

Level ground beneath the raised bed prior to assembly.

Your new Garden will be open on the bottom which enables plant roots to access soil nutrients below ground level. If there are gophers or moles in the garden area, lay hardware cloth, rocks or bricks (not included) on the floor of the unit, before adding soil.

Lay down a sand perimeter base for the Garden frames to sit on if possible. Sand offers excellent drainage and will make it easier to level bed frames.

The Garden can also be located on almost any flat surface - sand, pebbles/gravel, concrete or asphalt. Preparing the soil and the sand base beneath the Garden will not be necessary. Consider lining the Garden with landscape fabric to prevent soil from seeping out. Twenty inches of soil should be plenty for most types of vegetables and flowers. Please check growing instructions for root depths prior to planting.

Once the Garden is Assembled - Add Soil

Use a quality soil ideal for growing vegetables, for the top 12 inches (approximately 4 cubic yards or 38 - 42 wheelbarrows). Any soil is suitable for the bottom 8 inches (approximately 2.5 cubic yards). Or, you may fill the bottom 8 inches with gravel, pebbles, rocks or wood chips.

Most 1/2 ton pickup trucks can haul 1 cubic yard of top soil if this is an option for you. Consider having soil delivered as opposed the buying bags by the cubic foot. There are 27 cubic feet in 1 cubic yard.

Fill the Garden to the top of the wood framing (the start of the metal screening). In a few weeks, the soil will settle/drop about 4-6 inches. Top up if necessary.

Add soil within two weeks of planting. Fertilizer may be required. Check with your local garden growing expert before adding any fertilizer!

Arranging and Planting Crops

Since requirements vary from region to region on how to arrange and plant crops, we recommend researching thoroughly before planting.

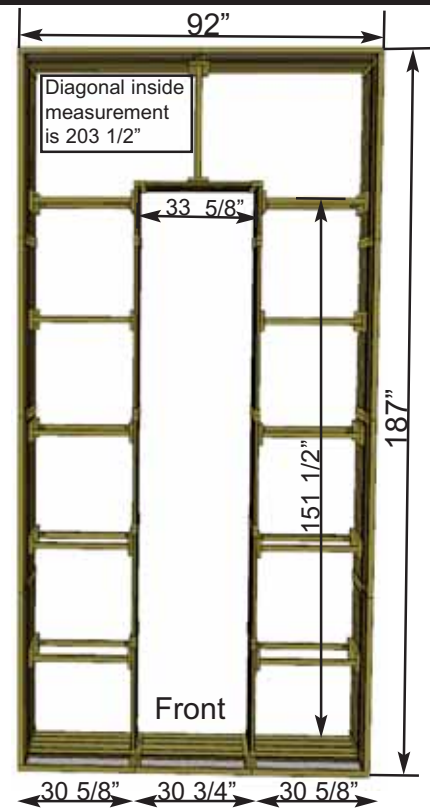

1. Orientate Panels as illustrated
(screens positioned to the inside).

10 - Side and Rear Wall Panels

(Part A - 46" w x 33 1/2" h).

2 - Front Panels

(Part B - 30 5/8" w x 33 1/2" h)

1 - Door Panel

(Part C - 30 5/8" w x 33 1/2" h)

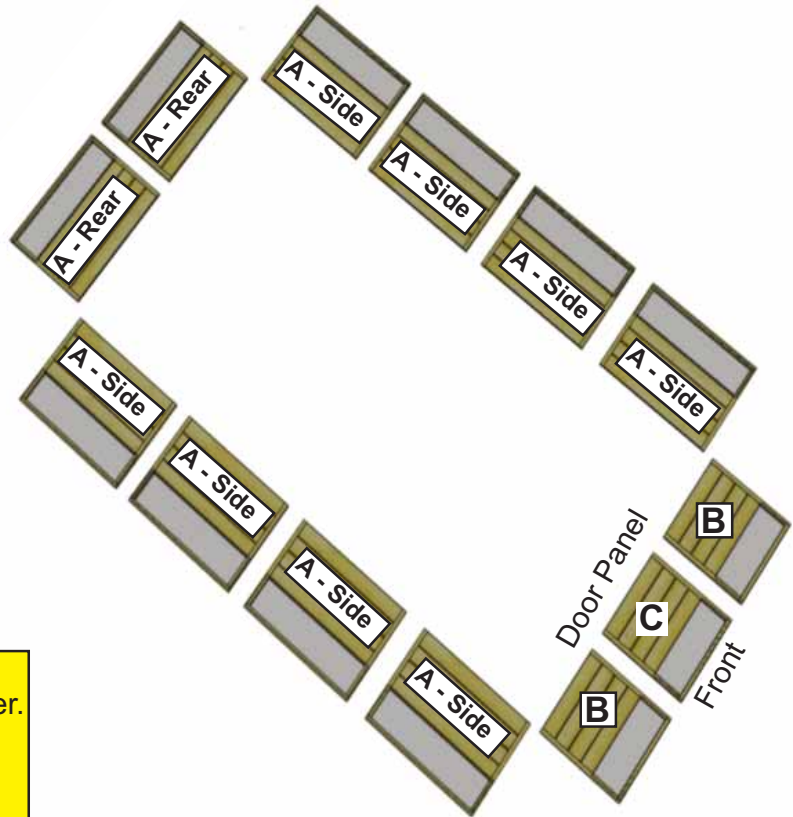

Before positioning panels, lay out footprint and level ground perimeter. If possible, dig a small trench and backfill with 1 or 2 inches of sand. Sand will make it easier to level panels.

Note: There is no difference between Parts B and C until later in the assembly manual when one will be used as a Door.

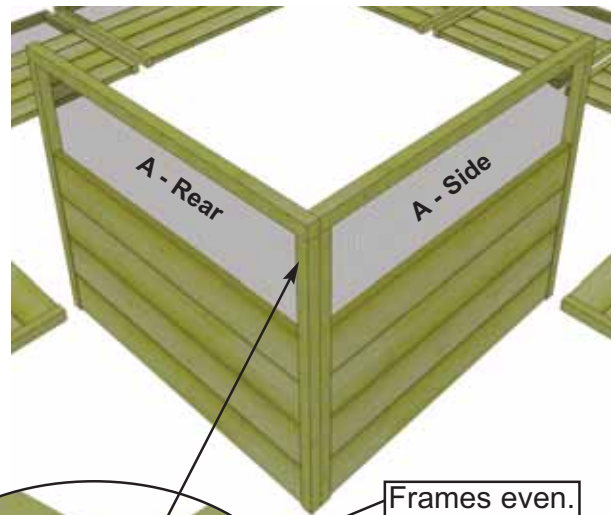
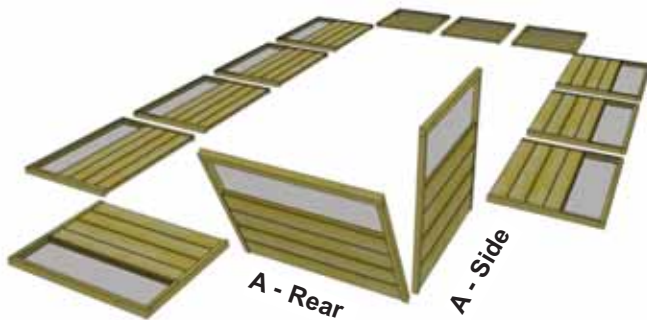

2. Starting in rear corner, position **Rear and Side Panels (Part A) - 46" wide** together so framing is flush at top and sides. When aligned, attach frames together at top with **1 - 2 1/2" Screw**. Use **Wood Clamp** to hold frames together. Pre-drill rear frame first with 1/8" diameter bit to prevent wood from splitting.

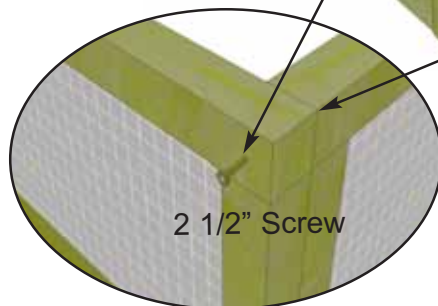

You can find the Square Drive Bit for the screws in with the Hardware Kit Bag.

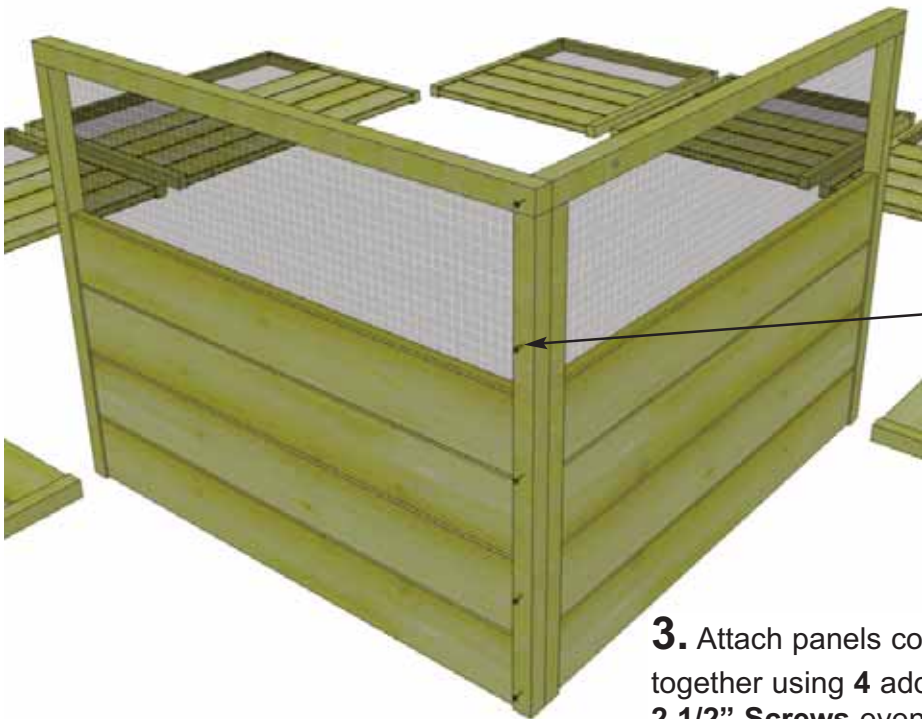

3. Attach panels completely together using **4** additional **2 1/2" Screws** evenly spaced on panel framing. Make sure panels are aligned prior to screwing. Pre-drill first to prevent wood from splitting.

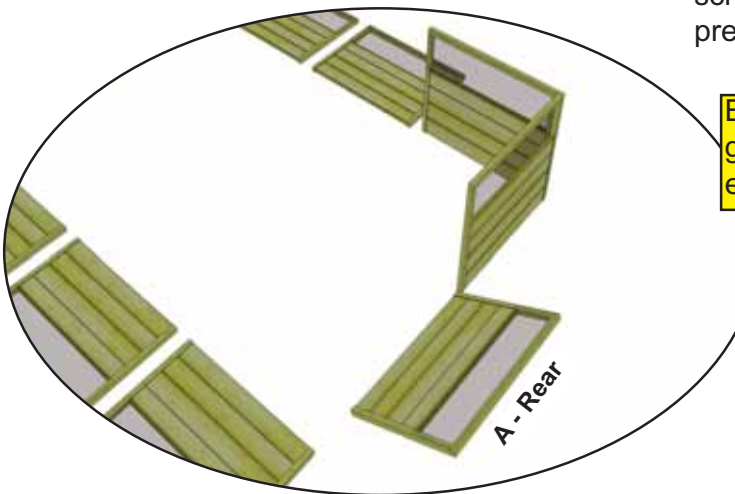
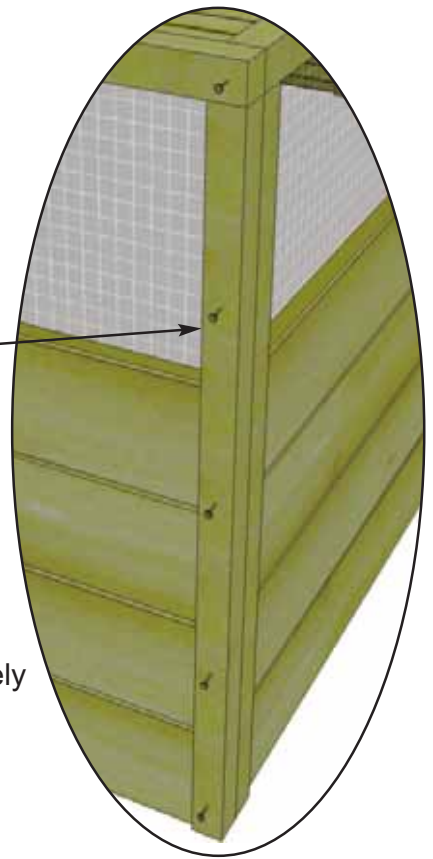

Be sure to level the ground so panels sit evenly.

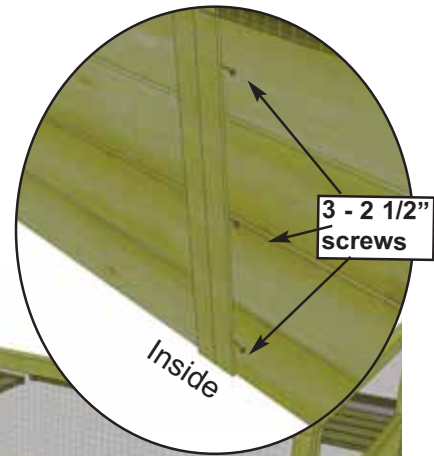

3 - 2 1/2" screws

Inside

4. Position and attach **2nd Rear Panel (Part A)** together making sure both rear frames are aligned at top and sides. Use **2 - 2 1/2" Screws** in the upper screen frame area as illustrated to the right. From the inside, angle screw **3 - 2 1/2" Screws** into panel framing to secure completely. Use **Wood Clamp** to hold panels tight together while screwing and pre-drill first to prevent wood from splitting.

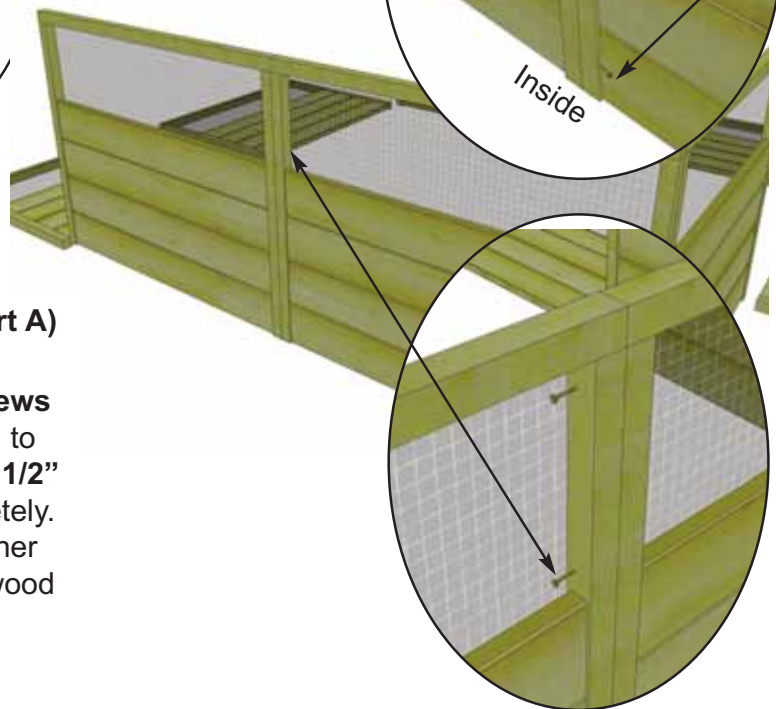

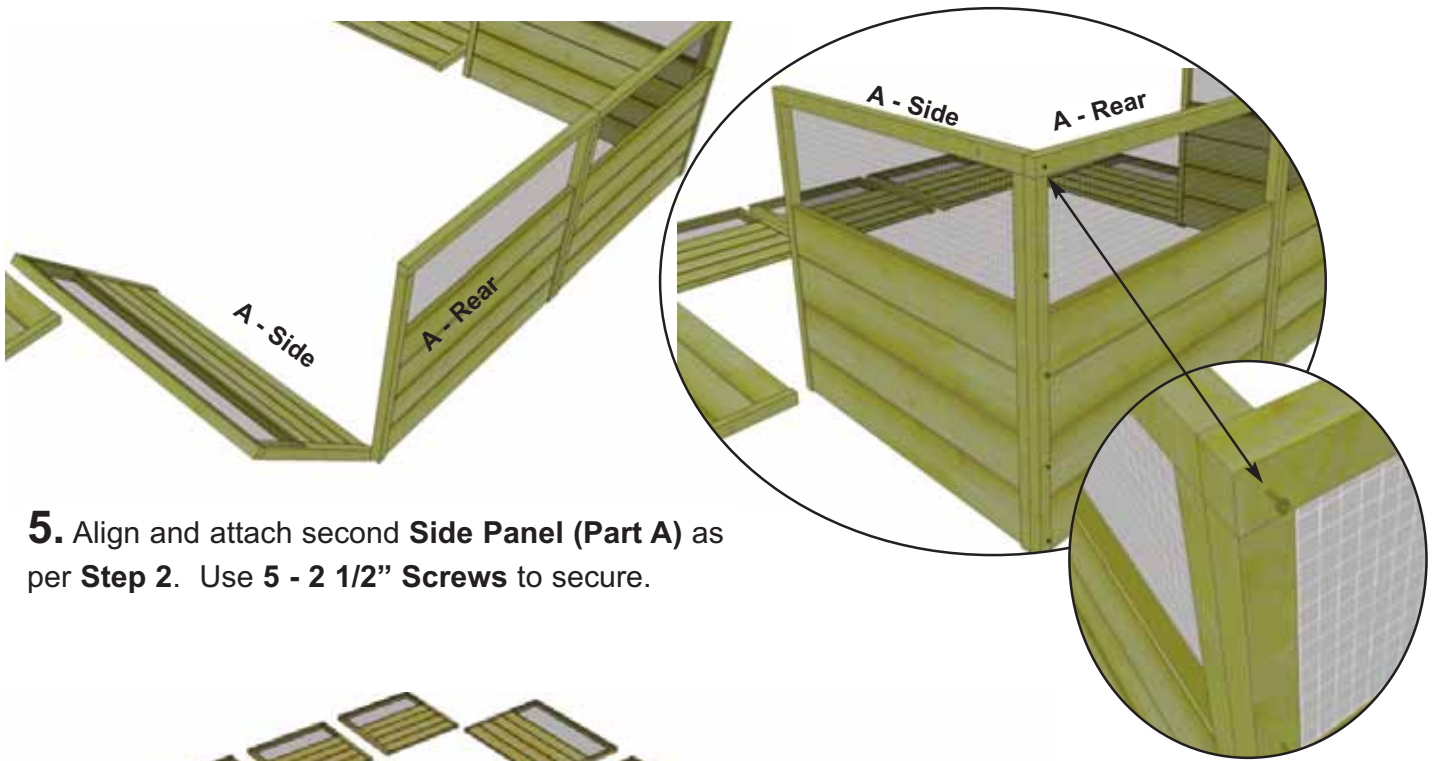

5. Align and attach second **Side Panel (Part A)** as per **Step 2**. Use **5 - 2 1/2"** **Screws** to secure.

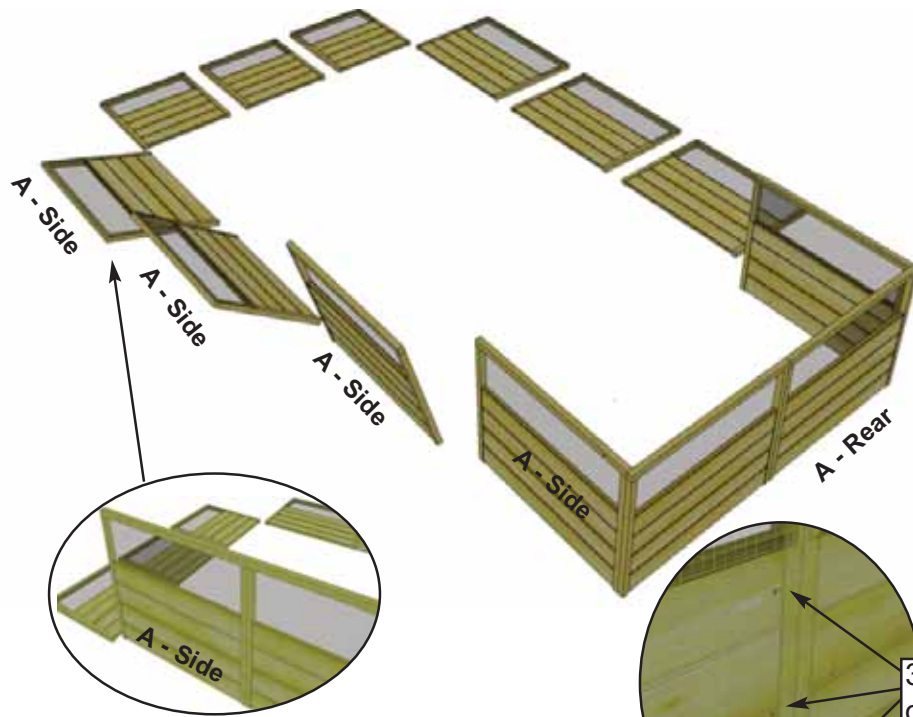

Be sure to level the ground so panels sit evenly.

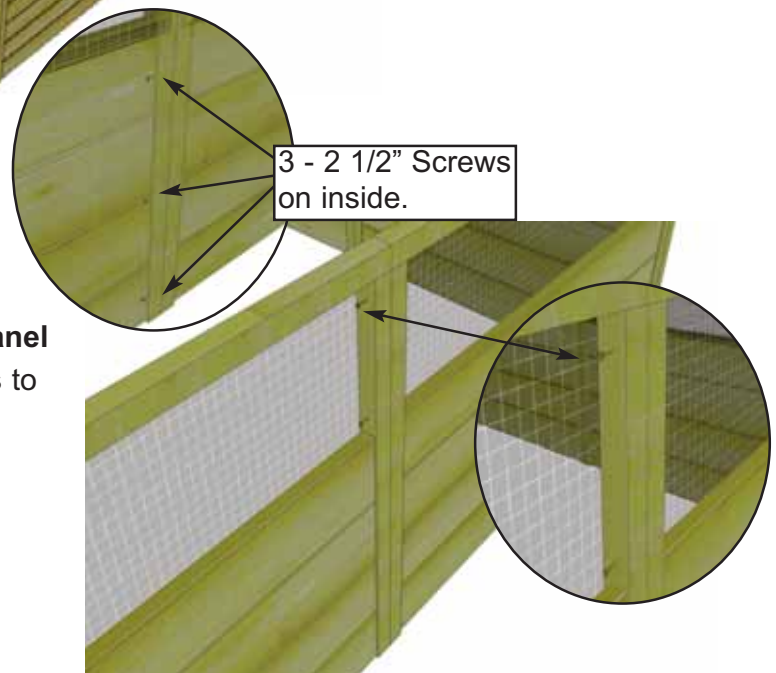

6. Align and attach the third and fourth **Side Panel (Part A)** as per **Step 4**. Use **5 - 2 1/2"** **Screws** to secure.

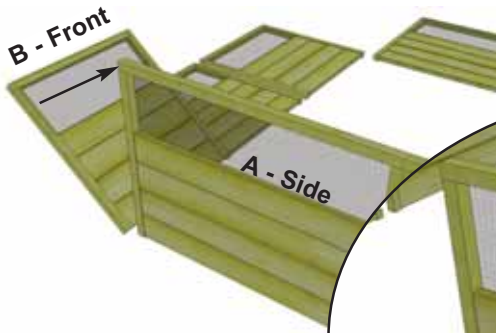

7. Align and attach **Front Panel (Part B)** - 30 5/8" wide to side panel with 5 - 2 1/2" Screws as per **Step 2**.

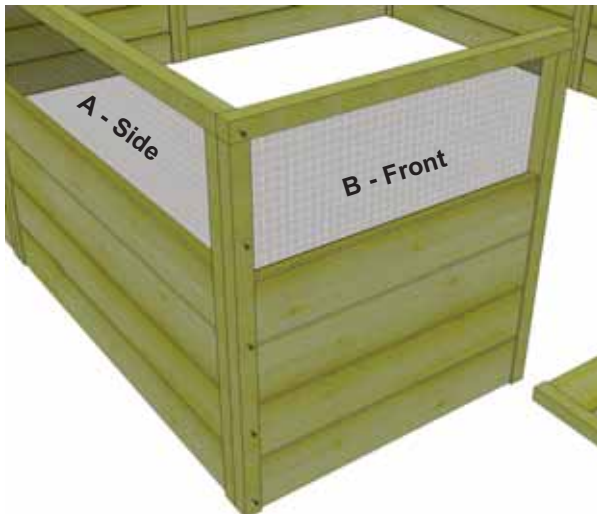
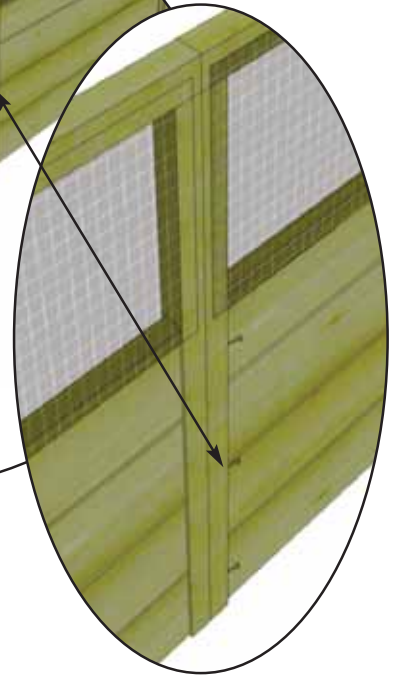
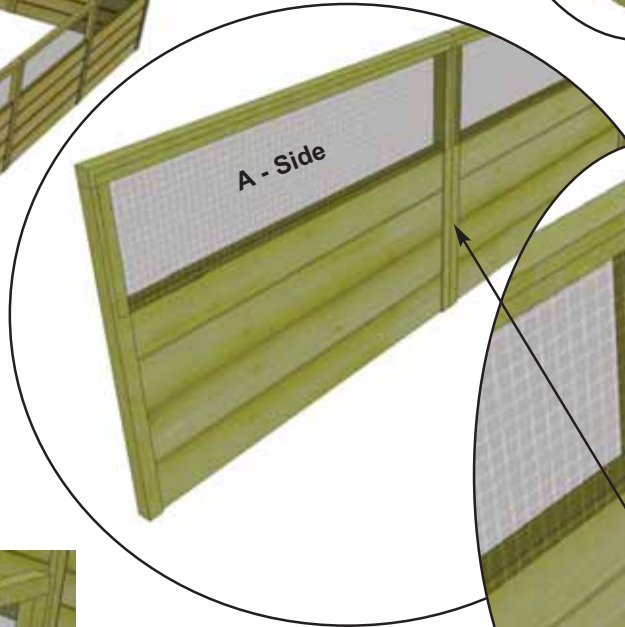
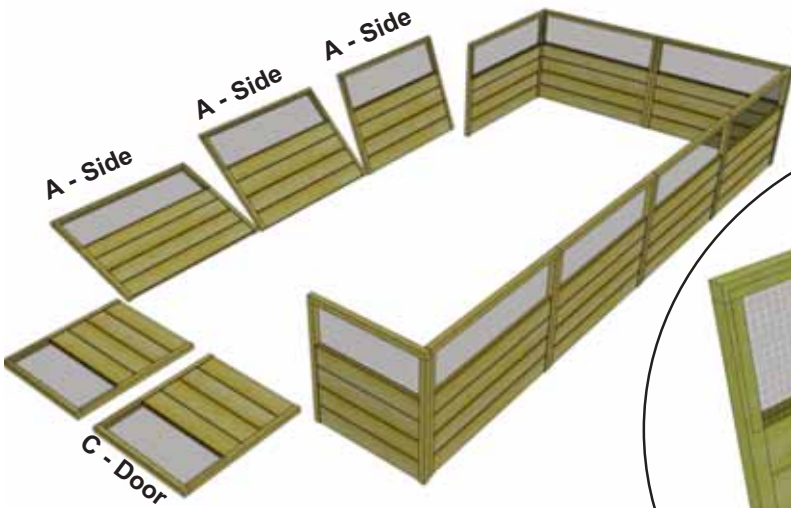
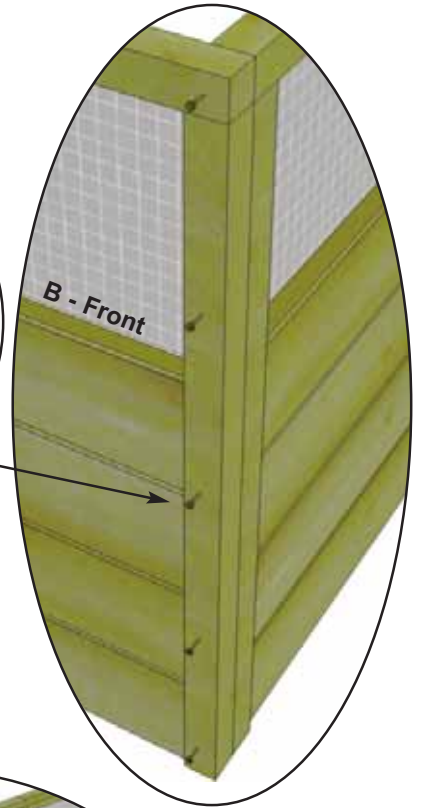
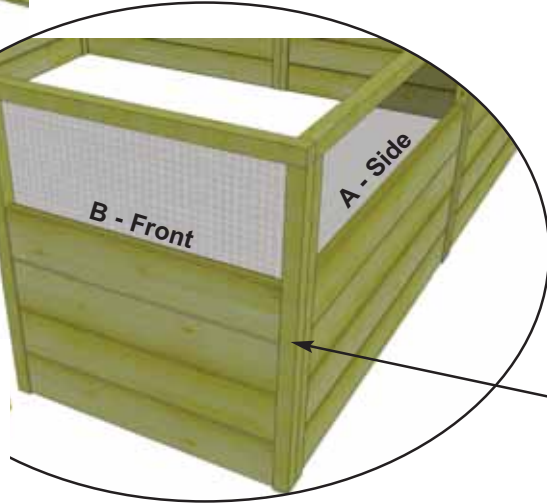

8. Align and attach remaining **Side Panels (Part A)** and **Front Panel (Part B)** as per **Steps 2, 3 & 4**. Attach with 5 - 2 1/2" Screws per panel.

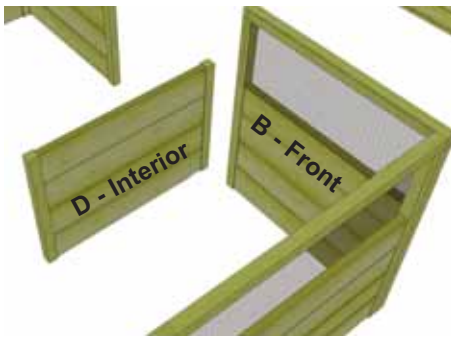

9. Locate all 7 Interior Panels (Part D) - 30 5/8" w x 22" h. and 2 Narrow Interior Panels (Part DD) - 15 3/8" w x 22" h. Panel siding is offset on framing. Orientate offset to the inside. Align frame of 1st Interior Panel (Part D) with the bottom of the front B panel. Line up Interior panel framing flush with front panel framing. Screw from front panel framing into interior framing with 3 - 2 1/2" Screws. Hold framings tight together while screwing.

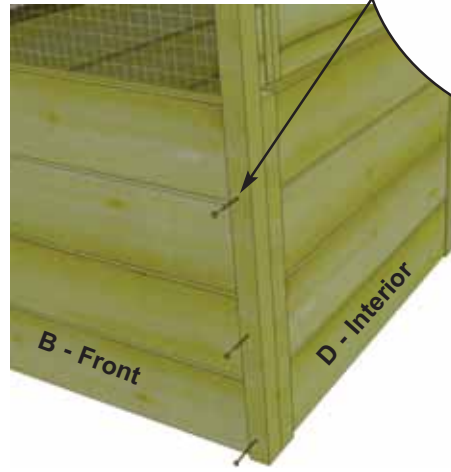
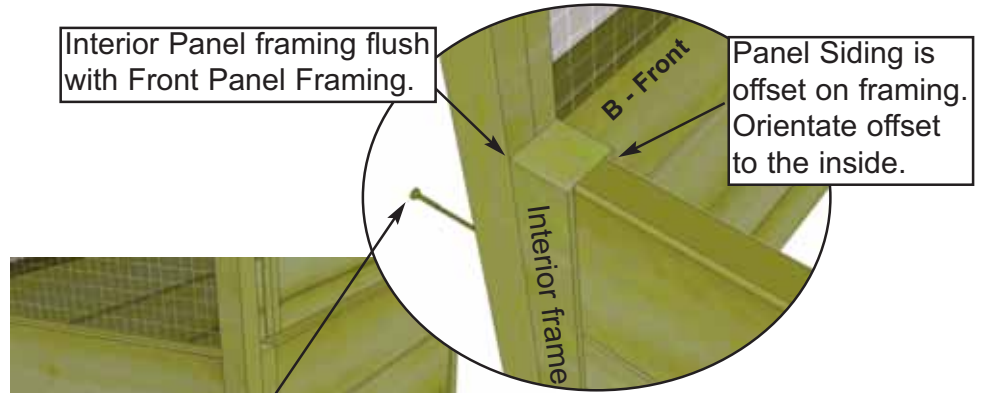

Be sure to level the ground so panels sit evenly.

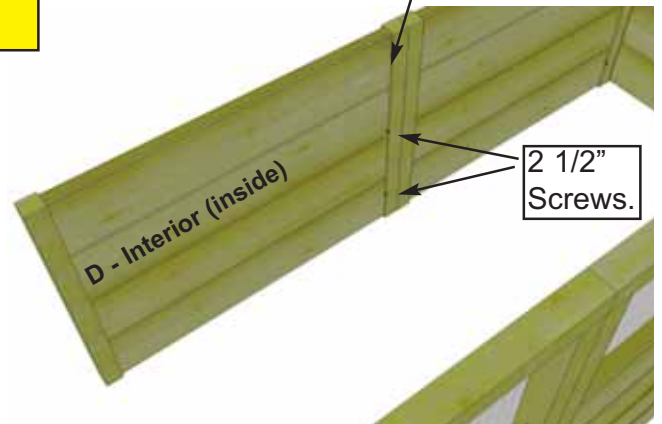
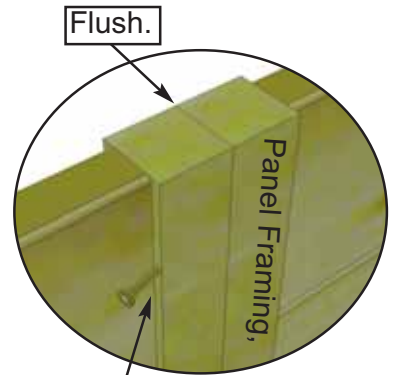

10. Align and attach framing of 2nd, 3rd and 4th Interior Panels (Part D) to 1st Interior panel framing. Angle screw panels together with 3 - 2 1/2" Screws from the inside.

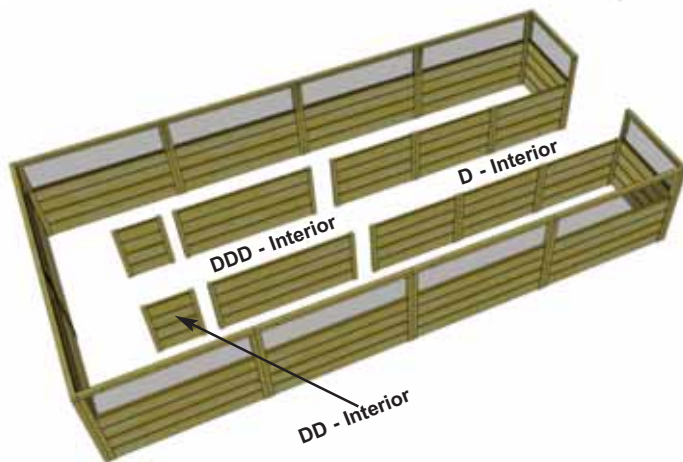
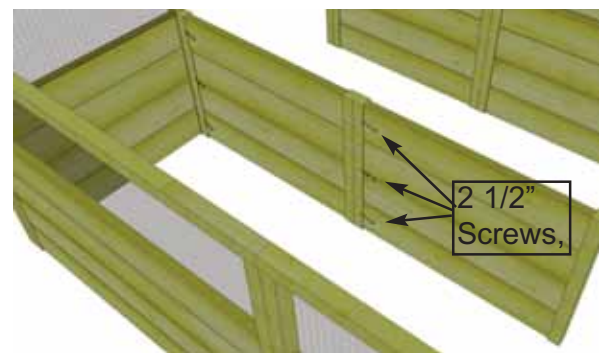
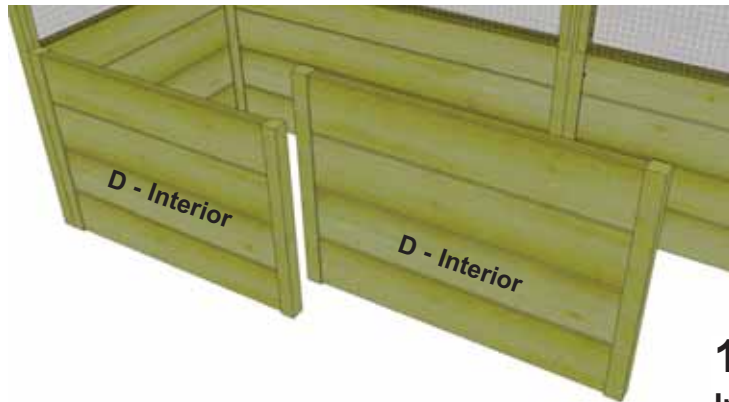

11. Align and attach framing of (Part DDD) and (DD Panels) as per Steps 9 & 10. Angle screw panels together with 3 - 2 1/2" Screws from the inside.

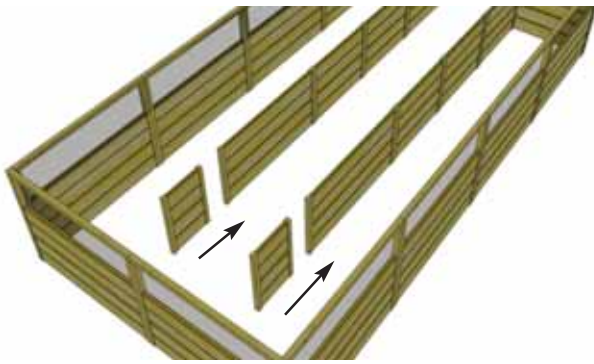

12. Align and attach final side **Interior Panels (Part D)** as per **Step 10**. Angle screw panels together with **3 - 2 1/2" Screws** from the inside.

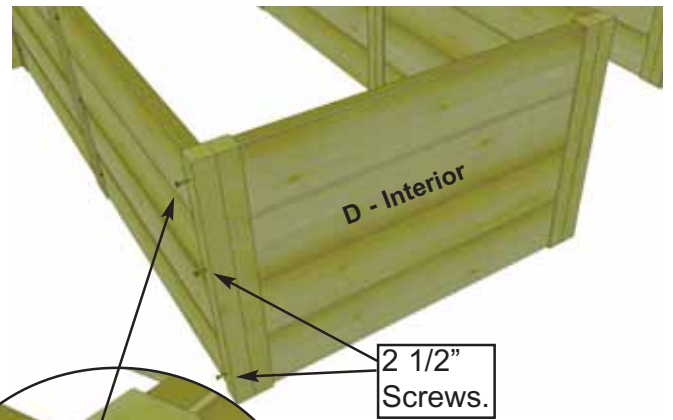
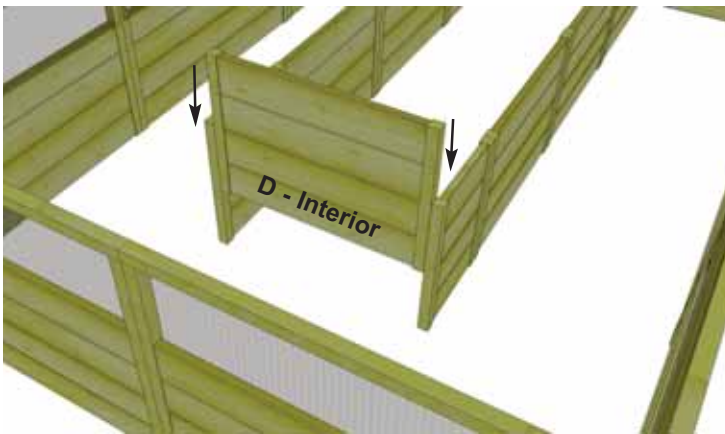

13. Align and attach **7th Interior Panel (Part D)** between frames of attached Interior panels. Attach with **3 - 2 1/2" Screws** per corner (6 screws in total).

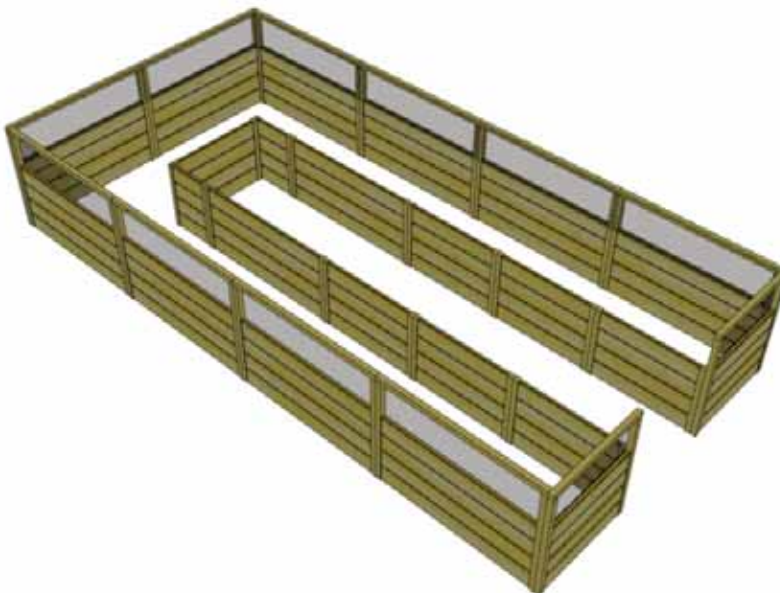
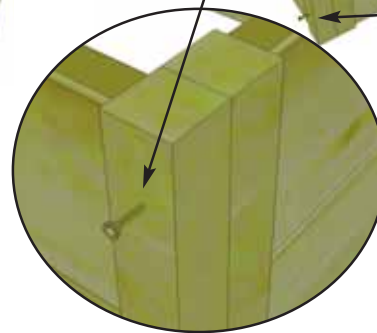

Wall construction is now complete. Do not add soil until structural ribs are installed in **Steps 14 - 19**.

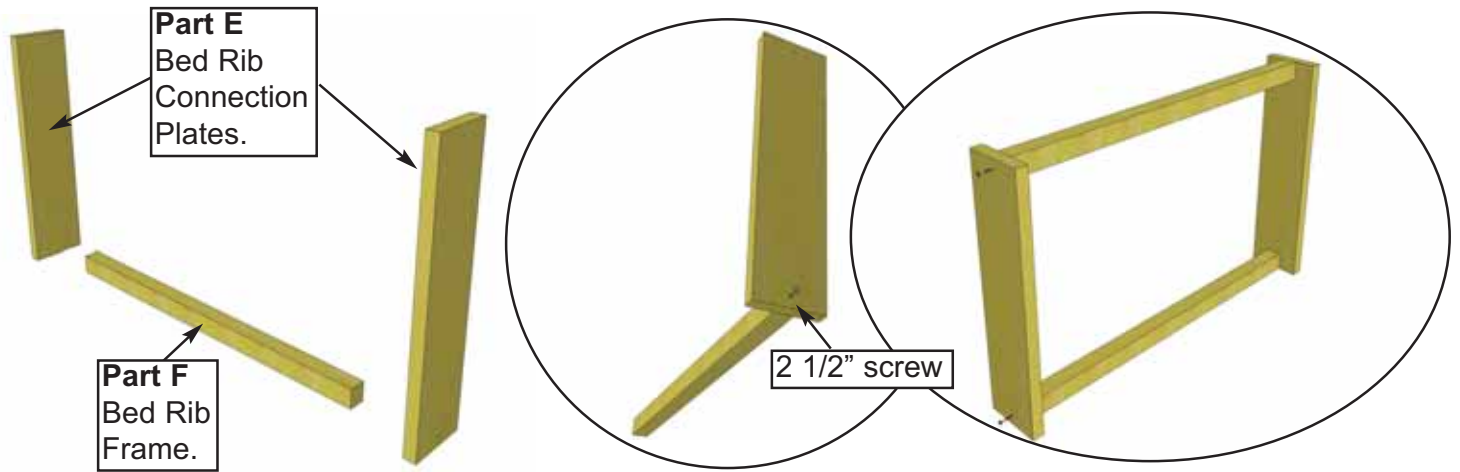

14. To complete rib assembly, locate all **22 Bed Rib Connection Plates (Part E)** - 1" x 5 1/2" x 20". **20 Bed Rib Frames (Parts F)** - 1 1/2" x 1 1/2" x 26 3/8" and **2 longer Bed Rib Frames (Part G)** - 1 1/2" x 1 1/2" x 29 1/4". On a level flat surface, screw connection plate and frame together with **1 - 2 1/2" Screw** per end. Align so plate and frame are flush at bottom. Complete both sides.

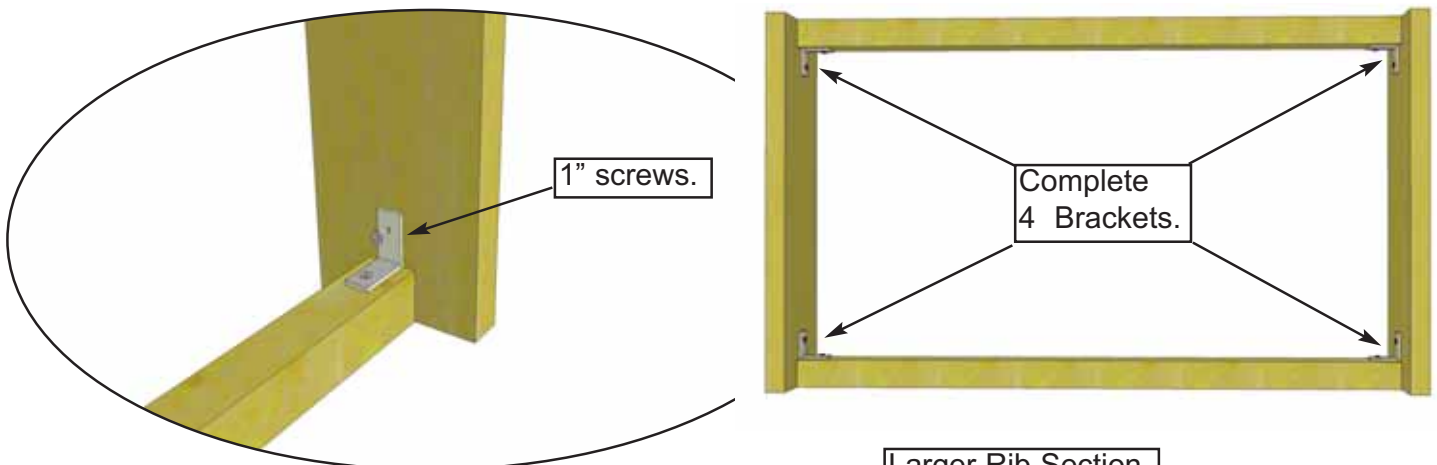

15. Locate "**L**" **Brackets** in hardware kit. Four brackets are required for completion of each rib section. 6 smaller and **1** larger rib sections need assembly. Position brackets in each corner and secure with **4 - 1" Screws** per bracket. Pre-drill first with 1/8" bit to prevent wood from splitting.

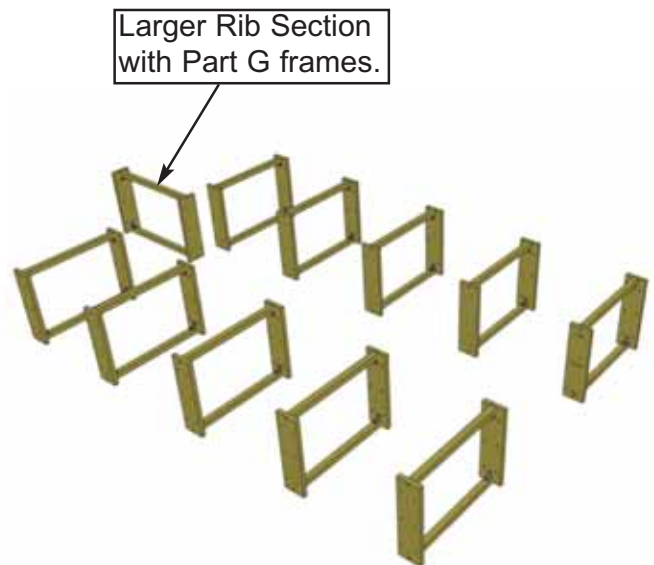

16. Complete **11** bed rib sections. **10** with **Part F Bed Rib Frames** (shorter) and **1** with **Part G Bed Rib Frames** (longer).

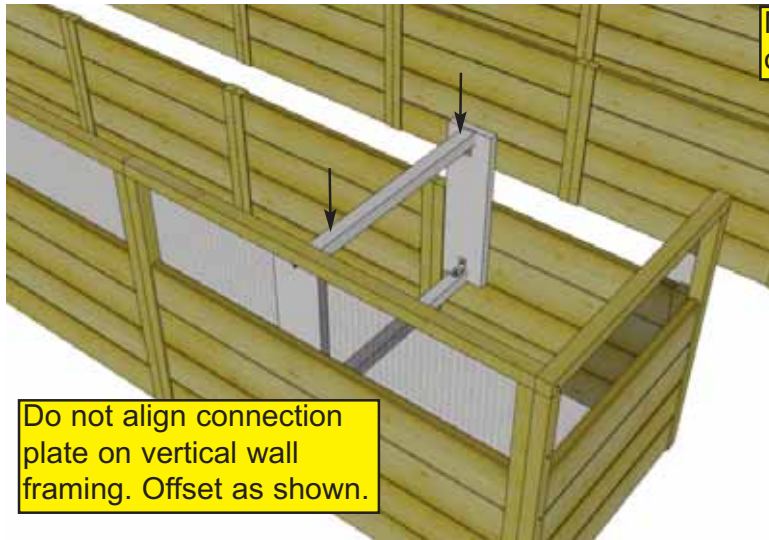

Note that connection plate is offset from inner panel joint.

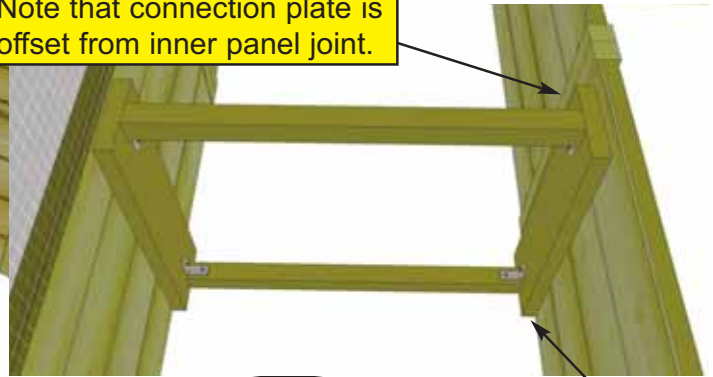

Flush with bottom.

Do not align connection plate on vertical wall framing. Offset as shown.

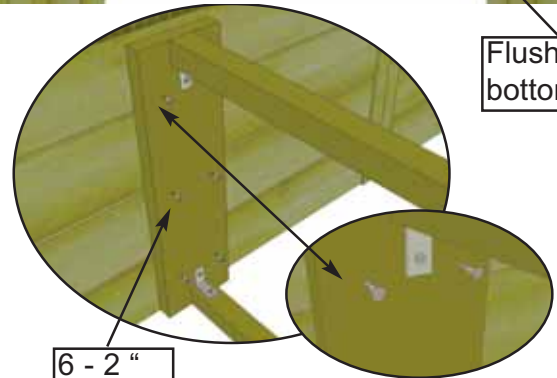

6 - 2" Screws.

17. Lift and position completed short **Bed Rib Frame** and place between side and interior panel siding. Do not center on panel framing. Align with bottom of panels. Secure with **6 - 2" Screws** per plate. Pre-drill to prevent Splitting. **Important - Do not over screw!** Complete both sides.

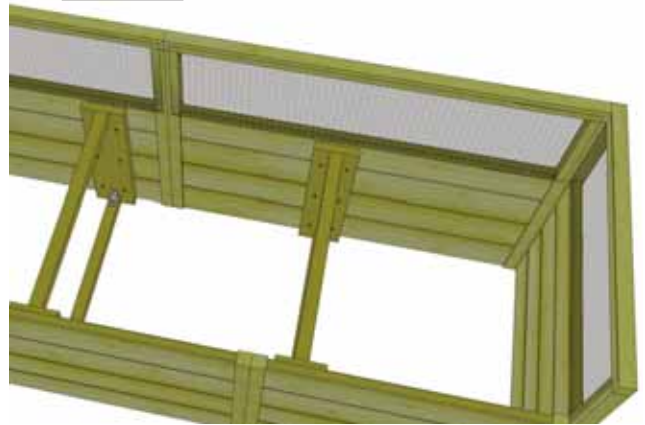

18. Complete remaining short **Bed Rib Frames (5)** as per **Step 17.**

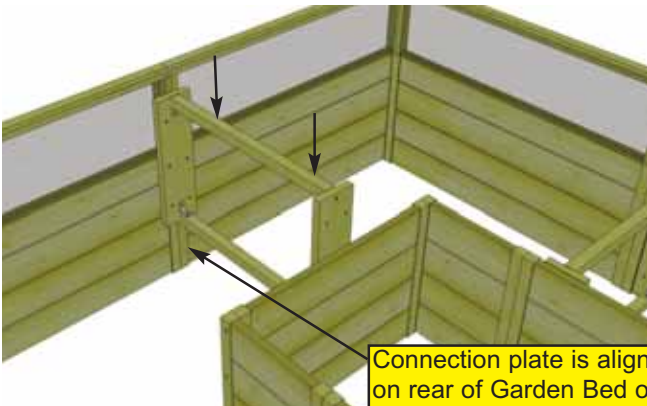
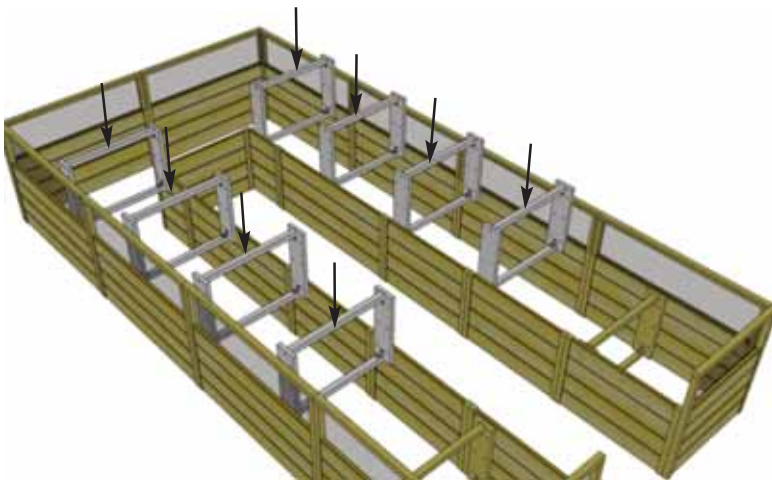

Connection plate is aligned with panel joint on rear of Garden Bed only.

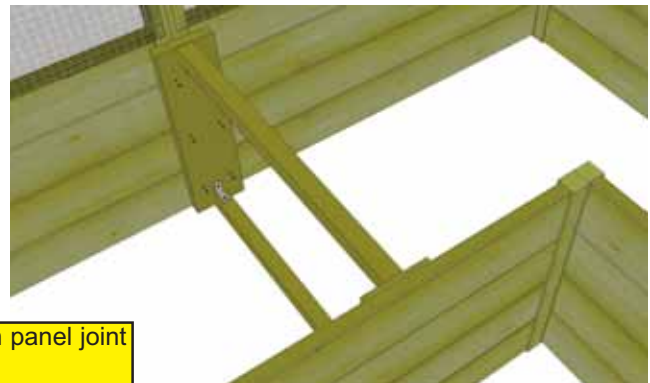

19. Lift and center completed longer **Bed Rib Frame** on rear and end interior panels. Align with bottom of panels. Secure with **6 - 2" Screws** per plate. **Important - Do not over screw!**

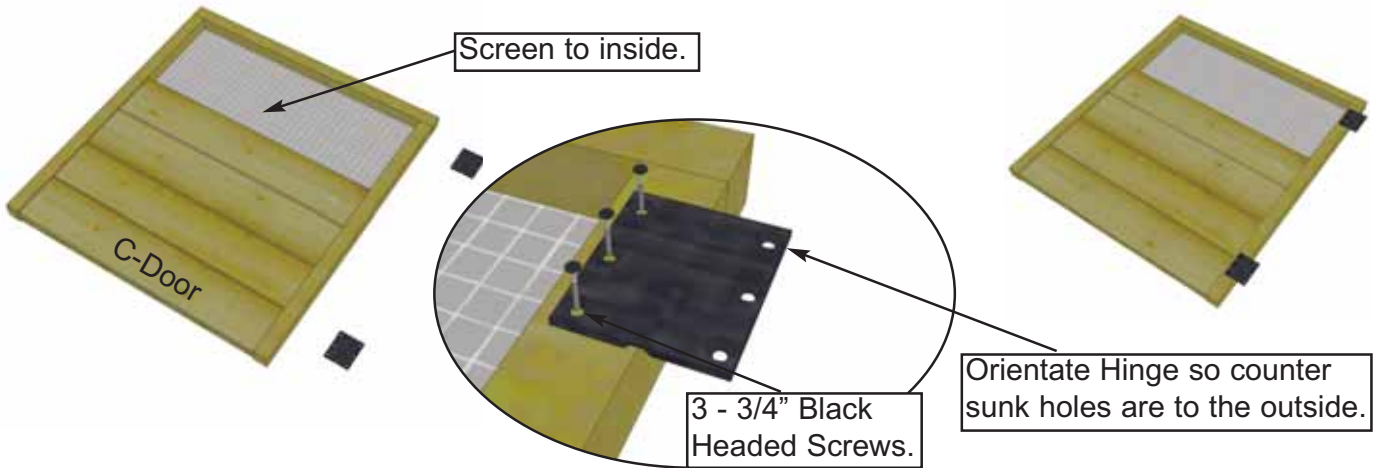

20. Locate **Door Panel (Part C) - 30 5/8" w x 33 1/2" h** and position on flat surface screen down. Attach both hinges to door panel with **3 - 3/4" Black Headed Screws** per hinge. Space hinges evenly on door frame. Pre-drill shallow hole first to prevent wood from splitting.

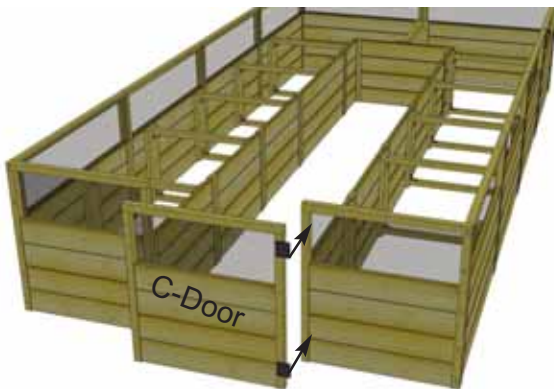

21. Attach Door to front wall framing with **3 - 3/4" Black Headed Screws** per hinge. Pre-drill shallow hole first to prevent wood from splitting.

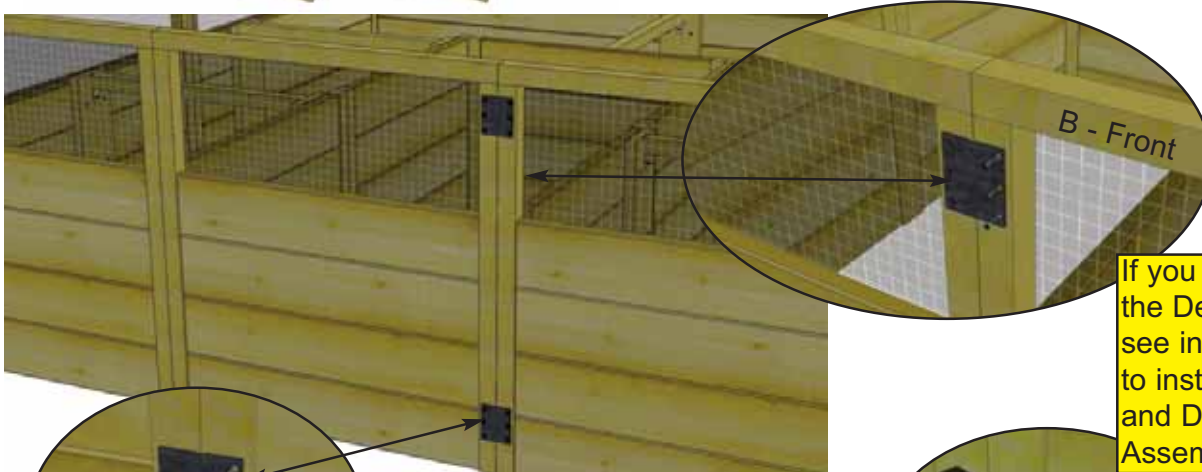

If you have purchased the Deer Fence Option, see instructions on how to install the Barrel Bolt and Door Stop in Option Assembly Manual.

22. Attach **Black Barrel Bolt** (male and female pieces) to door and front wall panel frame with **6 - 3/4" Black Headed Screws**. Pre-drill first to prevent wood from splitting. Do a dry run first to confirm fit before attaching. On inside of Interior panel frame, attach **Door Stop - H (3/4" x 1 1/2" x 4")** with **2 - 1"** centered vertically on frame.

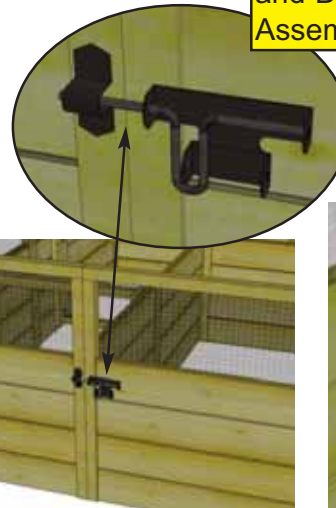

Front Wall framing.

Door Stop (H)

D - Interior

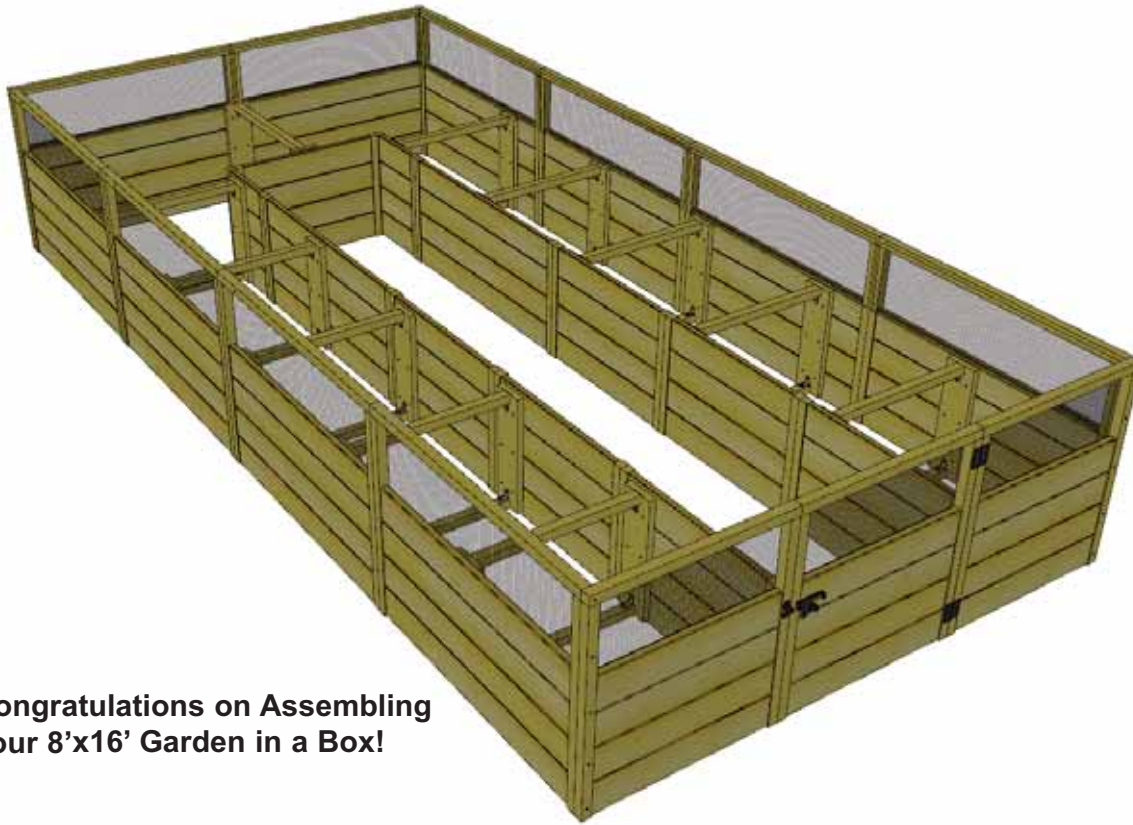

**Congratulations on Assembling
your 8'x16' Garden in a Box!**

We strongly recommend you now line the inner walls of your Garden in a Box with landscape fabric or 6 mil poly/plastic sheeting (not provided) before filling with soil.

We hope your experience constructing our **8'x16' Garden in a Box** has been both positive and rewarding. We value your feedback and would like to hear back from you on how well we are doing in the following areas:

- 1. Customer Service**
- 2. On Time Shipping**
- 3. Motor Freight Delivery**
- 4. Quality of Materials**
- 5. Assembly Manual**
- 6. Overall Satisfaction.**



The materials contained in this Assembly Manual may be downloaded or copied provided that ALL copies retain the copyright and any other proprietary notices contained on the materials. No material may be modified, edited or taken out of context such that its use creates a false or misleading statement or impression as to the positions, statements or actions.

Please call, write or email us at:

Canadian Address
9393 287th Street
Maple Ridge, British Columbia
Canada V2W 1L1

United States Address
P.O. Box 96
Sumas, Washington
USA 98295

Toll Line: 1.888.658.1658

Fax: 1.604.462.5333

sales@outdoorlivingtoday.com