

Green.tek

417 E. Fulton Street • Edgerton, WI 53534
800-747-6440 • Fax: 608-884-9459

ASSEMBLY & STORAGE GUIDE

Polycarbonate Multi-Wall Sheets

SHIPMENT HANDLING AND CARE

INSPECTING YOUR PANELS

It is important that you inspect your panels upon receipt of the shipment. **THIS WILL SAVE YOUR COMPANY MONEY.** Count all panels and inspect all panels for damage, especially concealed damage. Make a notation of the damaged or short shipped material on the Bill of Lading **BEFORE** you sign the document. Report all shortages and damage to your dealer and keep a signed copy of the document. Failure to inspect and sign will result in you purchasing new panels.

STORAGE REQUIREMENTS

Polycarbonate crates should be stored in warehouse areas not exposed to direct heat or light which could make the removal of protective film difficult. Supported, sloped stacking is recommended, but sheets may be stacked up to 3' high on a flat, even, supported surface.

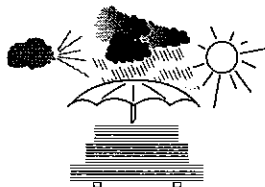

GENERAL INSTALLATION

PROTECTIVE MASKING FILM

The panels are supplied with protective masking or film on the panel. Remove the underside layer of film prior to installation and the outer film as soon as the installation is completed. Do not leave the film on the panels for a prolonged period of time as it may "bake" onto the panels and make it difficult to remove.



UV SIDE OUT

Install the panel UV side out. The panel should be labelled "This Side Out". If no label is found, look for a production date stamp along the vertical edge of the panel and install this side out.

SCAFFOLDS

Apply panels with a professional greenhouse roof scaffold. Lay the scaffold legs in the gutter of the roof and the ridge of the house. **DO NOT WALK** on the panels at any time. This can cause damage to the panel.

PROTECT AGAINST DUST INFILTRATION

The upper end of the panels should be sealed using an adhesive backed solid tape. The lower panel edge should be sealed with an adhesive backed permeable tape to allow for condensation moisture to escape and prevent dust or contaminants from entering the panel.

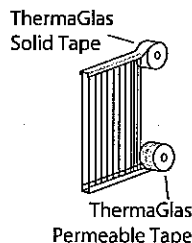

ALLOW FOR CONDENSATION DRAINAGE

Weep holes should be drilled in the bottom glazing members so that moisture can escape. These holes should be 1/8" in diameter and drilled every 18"-24" apart.

THERMAL EXPANSION

Allow for thermal expansion during installation at a rate of 1/8" per 3 feet at 100°F temperature differentials in both width and length of the sheet. Colored panels require an additional 30% spacing, this includes leaving a small gap at the ends of engagements channels.

It is recommended to install sheets at ambient temperatures of 50-77°F. to reduce excessive expansion and contraction of the panel.

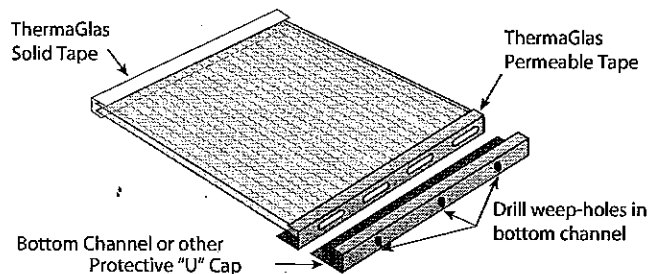

CUTTING PANELS

ThermoGlas panels can be cut with a power circular saw equipped with a triple chip fine-tooth blade. Dust can be removed from the flutes by applying compressed air or with a vacuum. A razor knife can be used with cuts made on both surfaces of the sheet to ensure a clean cut.

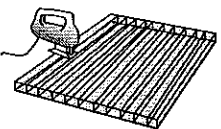

PANEL ORIENTATION

ThermoGlas sheets should be installed with the rib channels in the direction of the slope for roof installation or in a vertical position for windows or walls. This position reduces accumulation of dirt inside the sheet and ease gravity drainage of condensation moisture.

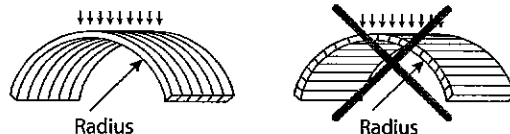

BENDING RADIUS

ThermoGlas is sufficiently flexible to allow vertically positioned panels to conform to arched construction. However, when installing 8mm ThermoGlas, it is not recommended that panels be affixed to curved surfaces where the curve radius is less than 55 inches. Affixing the panel to tighter radii surfaces may result in local stress crazing and deterioration over time.

Product Profile	Panel Thickness	Minimum Bending Radius		
		mm	ft.	in.
Twin Wall	6 mm	1,050	3.44	41.3
	8 mm	1,400	4.59	55.1
	10 mm	1,750	5.74	68.9
Triple Wall	8 mm	1,400	4.59	55.1
	10 mm	1,750	5.74	68.9
	16 mm	2,800	9.18	110.2

SEALING AND BONDING

Only compatible silicone sealants should be used with ThermoGlas panels if required. Silicone sealants are not typically needed when installing ThermoGlas panels. However, if there is a need to seal odd cuts or gaps approved silicone sealants can be used to seal these gaps. Contact your dealer for a compatible sealant if needed.

Polycarbonate Multi-Wall Sheets - Continued

LOADING - DISTANCE BETWEEN PURLINS AND WALL GIRTS

Based on two-sided clamping method with mid-sheet support(s) for greenhouse applications

Profile	Panel	Recommended Span Under Given Load (Wind / Snow Load)				
		10 psf	15 psf	20 psf	25 psf	30 psf
Twin-Wall	6 mm	32 in.	27 in.	26 in.	25 in.	24 in.
	8 mm	39 in.	35 in.	32 in.	30 in.	29 in.
	10 mm	49 in.	42 in.	37 in.	35 in.	33 in.
Triple Wall	8 mm	38 in.	34 in.	31 in.	29 in.	28 in.
	10 mm	48 in.	41 in.	36 in.	34 in.	32 in.
	16 mm	63 in.	55 in.	49 in.	45 in.	41 in.

1. The data is based on load tests on typical multi-wall sheets and additional extrapolations.
2. The data is based on a maximum deflection of 1/20 of the span (5%) using continuous, multi-span supports
3. The data refers to mid spans. The edge spans (lower & upper ends) should be smaller by about 20%
4. The sheets can withstand even higher loads or wider spans without failure, but the deflection may then grow to almost 1/10 the span (10%)

Distance between Girts (horizontal wall support members)

Vertical wall panels should have girt spacing no greater than 4 feet on center. Attachment should occur at the top and bottom of the panel. It is recommended that bottom edges of vertical ThermaGlas panels be affixed to glazing members, rather than simply burying the panel ends into the ground. This will minimize algae growth within the panel cavities.

FASTENING

FASTENERS

Use a screw that is appropriate for the thickness of the panel being applied. All screws should feature a corrosion resistant long-life coating to ensure durability. Stainless steel fasteners are recommended in extremely corrosive environments.

ThermaGlas 8mm panels should be directly point fastened at each purlin location using #10 x 2" wood grip screw or #12 x 2" self-drilling tapping screw with a 1" (25.4 mm) Umbrella Washer.



1" ThermaGlas Spacer Washers should be used under the panel at every point fastener to keep panel elevated at the same height as the support rafter, bottom channel, or ridge, and to help reduce condensation drip at purlins.

PRE-DRILLING

A hole must be pre-drilled into each screw location. The diameter of that hole should be 2mm or 1/16" larger than that of the screw to allow for thermal expansion movements. Special attention should be given to drill all required holes perpendicular to the face of the material.

OVER-TIGHTENING

An electric screwdriver with an adjustable clutch should be used to tighten screws. It is imperative that over tightening be avoided in order to avoid undue stresses, which would cause premature failure and buckling of the sheet. Be certain to insert the screws perpendicular to the material face, as inclined insertion could damage the sheet and/or result in leaks.

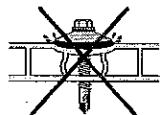

INCORRECT
Overtightened

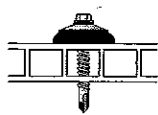

CORRECT



INCORRECT
Non-Perpendicular
drilling and insertion

FASTENER LOCATION / SPACING

At intermediate purlins: The sheets have to be fastened to the purlins by fastening screws, inserted along the supporting purlins, spaced about 24" (600 mm) apart, and 12" (30 mm) from the Support Rafter and Snap-Cap.

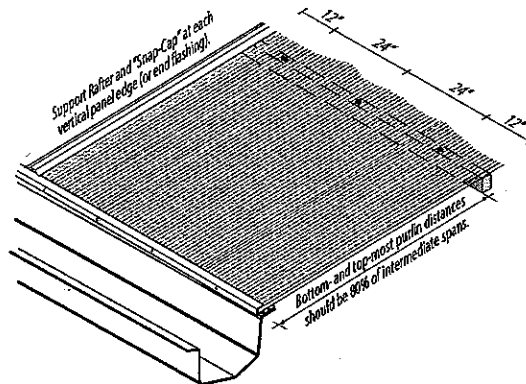

At panel ends: If panel ends are inserted into glazing profiles with channel recesses designed to accommodate polycarbonate (at ridge, gutter or eave), fasteners are optional, but are highly recommended when wind or snow loads can be excessive. If fasteners are used at these points, placement should be the same as at intermediate purlins.

When panel end over hangs eave: Along the edge purlin (or gutter) where the panel is not inserted into a channel recess, the fastening screws should be spaced about 12" (300 mm) apart. Permeable Tape and a Protective U-Channel should be used for this type application. Note: Panel ends should not over hang the eave by more than 3" (76mm).

Along vertical edges of panel: Fasteners are not necessary along the vertical edges of the panel. Securing the vertical edges of the panels is achieved with ThermaGlas Support Rafter and "SnapCap", ThermaGlas "H" Profiles, or other similar glazingsystem components.

POST INSTALLATION CARE

CHEMICAL RESISTANCE

Information about many compatible chemicals, sealants, and adhesives can be found by contacting Palram Americas or by visiting the Palram hort Web site at: <http://www.palramhort.com/compatibility.html>

SHADE COMPOUNDS

IMPORTANT NOTE: Many typical greenhouse shading compounds are aggressive to polycarbonate. **WARNING:** Shading materials containing vinyl binders or organic solvents are aggressive to polycarbonate and should be avoided. Contact the manufacturer of the shade compound you wish to use and gain their approval for use with polycarbonate.

CLEANING AND CARE

Self-cleaning by rain is usually sufficient. If required, use diluted mild household non-abrasive detergents for additional cleaning. Pre-wash with warm water, then wash area to be cleaned with a soft sponge or brush, preferably with hot water, until clean. Rinse with water and dry with a soft non abrasive cloth. Large areas may be professionally washed with a high-pressure water jet, possibly adding a mild compatible detergent, and/or steam jet. Avoid allowing the spray tip to come too close to the panel. Pressure washers often have enough pressure at the spray tip to penetrate or tear the panel.

Heavy oil or tar stains can be removed with an ethyl alcohol watery solution. Rub the area gently with a soft rag. Follow with general cleaning as stated above, rinsing thoroughly with water before drying. Avoid cleaning the panel when dry, as the sand and dust particles cling to the exterior of the panel and may scratch the surface (minor surface scratches will not damage the panel, the scratches will simply reduce optical clarity). Avoid repeated sliding of sheets over each other, even when protected by the protective film. This action generates an electrostatic charge in the sheet, attracting dirt and dust and hindering cleaning.