

# SOLO<sup>®</sup> Operator's Manual & Parts List

US9456702 (04-08)

Compression Sprayers: 454, 456, 456 SW, 457, 454HD, 456HD, 457HD, 454V, 456V, 457V, 407CI



**STOP!**

If you are missing parts, instructions or have questions, **DO NOT** take this unit back to the store. Call 1-800-SOLO-INC. Solo will send the missing parts/information to you promptly.

## WARRANTY:

Solo model 454, 456, 456 SW & 457 sprayers are covered by Solo's 5-YEAR LIMITED WARRANTY. Solo manufactured parts which fail due to defective material or workmanship will be repaired or replaced without charge. See page 6 for full details.

## SAFETY PRECAUTIONS:

- Do not exceed 45 psi pressure.
- Do not fill with, use or spray flammable materials.
- Do not use gasoline, acid, caustic or potentially injurious chemicals.
- At the time of manufacture of this sprayer, we are not aware of any approved plant protection chemicals which would adversely affect this sprayer when applied in their usual concentration.
- Observe the recommendations of the chemical manufacturer.
- Prior to removing any part of the sprayer pull the pressure relief valve to release any pressure in the tank.
- Wear rubber gloves, safety goggles and appropriate protective clothing.
- After pumping be sure handle is in the locked down position.
- Individuals should be trained in the proper use of this sprayer. Where training is not available, individuals should study and follow the procedures detailed in this manual.
- Do not use acetone based chemicals.



## WARNING:

Chemicals can be harmful to individuals and the environment if improperly used. In addition, some chemicals are caustic, corrosive, or poisonous and should be avoided. Read warnings and chemical manufacturer's instructions. Solo high density polyethylene sprayers are fitted with Viton<sup>®</sup> seals which are resistant to a wide variety of agricultural, industrial and household chemicals; however, care should be exercised to ensure that sprayer components are clean, functioning properly, and in a good state of repair before and during use. If in doubt about a particular chemical, check with manufacturer. If you suspect or observe indications that the material may be unsafe in a Solo sprayer... **STOP! Do Not Use or Apply Chemical. ALWAYS WEAR RUBBER GLOVES, SAFETY GOGGLES AND APPROPRIATE PROTECTIVE CLOTHING.**

- Read and follow operating instructions.
- Do not fill sprayer over maximum fill mark. Releasing pressure in an overfill condition can cause harmful venting of sprayer contents.
- Relieve pressure only with sprayer upright and while standing on the side of the sprayer opposite the pressure relief valve. Venting of sprayer contents can occur if liquid is over bottom of relief valve.
- CAUTION: To prevent injury from ejected pump assembly and/or solution, never stand with face or body over the top of the tank when pumping, or loosening pump.
- Do not modify sprayer or pressure relief valve.
- Never spray in the direction of humans, animals or property which might be injured or damaged by spray formula.
- Do not use disinfectants, solvents or impregnating agents unless first tested to ensure they are not harmful to the environment and sprayer.
- Do not use liquids with a temperature above 120°F (45°C).
- Remember that a sprayer with liquid is a significant amount of weight (8 lbs. per gallon). Use caution when bending, leaning or walking. Bend only at the knees and support yourself as required to ensure personal safety.
- Do not inflate sprayer without liquid in the tank.
- Do not climb on ladders, trees or other unsteady or potentially unsafe structures.

## ASSEMBLY INSTRUCTIONS FOR WAND

1. Ensure that the O-ring is on the non-threaded end of the wand.
2. Insert the non-threaded end of the wand into the O-ring into the open end of the shut-off valve.
3. Tighten the screw cap.

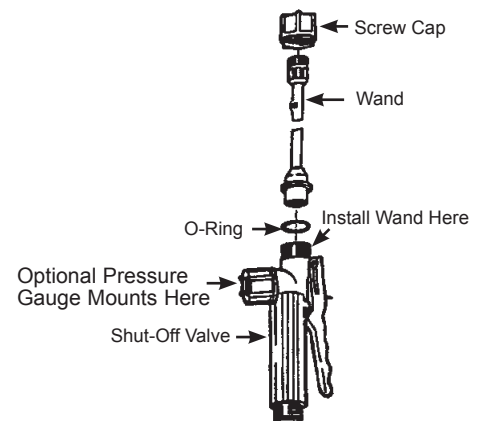

## CUSTOMER SERVICE COMMITMENT FROM SOLO'S SERVICE DEPARTMENT

In the event the sprayer you have purchased has missing or damaged parts, please call 1-800-765-6462, 9:00 AM—5:00 PM EST. In order to assist your service representative, please have the following information available: sprayer model number, part description and part number. A parts list is included in your operator's manual.

Solo is committed to your satisfaction and is continuing its efforts to earn your future business.

Visit us on the web at [www.solousa.com](http://www.solousa.com)  
Troubleshooting and parts ordering available online.

## USING THE ADJUSTABLE NOZZLE

To change the spraying pattern, first make sure the retaining nut (2) is screwed tight to the elbow (5). If it is not tight, the nozzle cap (1) and nozzle body (3) will rotate inside the retaining nut and the nozzle will not adjust. For a straight stream pattern, rotate the nozzle cap outward. For a hollow cone pattern, rotate the nozzle cap inward towards the retaining nut. If it becomes difficult to rotate the nozzle cap, remove the nozzle cap from the nozzle body and lubricate the O-ring on the nozzle body with a non-water soluble grease\*.

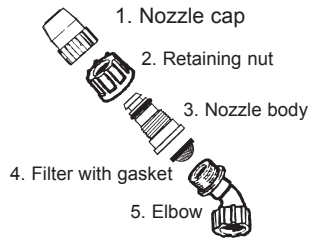

## REMOVING ADJUSTABLE NOZZLE

Unscrew the nozzle cap (1) from the nozzle body (3). This is best accomplished while the retaining nut (2) is securely fastened to the elbow (5). Next, unscrew the retaining nut (2). Push the nozzle body (3) out of the retaining nut (2). The filter (4) will come out with the body. To re-install the nozzle, reverse the above instructions.

## OPERATION:

- Before using sprayer with chemicals, fill sprayer with fresh water to assure that you have it properly assembled; pressurize and then practice spraying. When thoroughly familiar with sprayer operation, follow normal operating procedures.
- Turn pump handle counter clockwise to remove pump.
- Fill tank with premixed formula up to desired level. (**Do not exceed maximum fill mark.**) Observe recommendations of chemical manufacturer.
- Tighten cap and pump assembly for a good seal.
- Pump to a maximum 45 psi or 3 bar pressure. The valve stem on the pressure relief valve will rise up to vent excess pressure over 45 psi.
- Start or stop spraying by squeezing or releasing the lever on the shut-off valve (3). The spray pressure can be monitored with an optional pressure gauge.
- Prior to every removal of pump (1), release pressure first by pulling up on the pressure relief valve stem (2).



## CLEANING:

- Carefully clean sprayer after every use.
- Pour or spray all remaining chemical out of sprayer.
- Pour a small amount of water for water soluble chemicals, or mineral spirits for oil-based chemicals, into the tank.
- Pressurize and spray through system until all liquid is gone.
- Repeat process with warm soapy water.
- Repeat process with warm clear water.
- Use an absorbent cloth to dry all internal surfaces.
- Follow the recommendations of the chemical manufacturer for disposing of waste water and chemicals.
- Do not use aggressive or abrasive cleaning agents.

## MAINTENANCE:

- Prior to storage, empty, clean and dry sprayer.
- Always store the sprayer in a dry area, protected from freezing, heat and sunlight.
- Lubricate O-ring in pressure relief valve with non-water soluble grease\* on a regular basis.

*Disassembly: Unscrew pressure relief valve from tank and pull the valve body out of the screw cap. Clean, lubricate, and replace.*

- **Pump Maintenance:** Pump pressure sealing is accomplished with an O-ring (5) on the pump piston (4) which moves within the cylinder (3). Periodically this O-ring should be greased with a non-water soluble grease\*. If worn, it should be replaced. A small umbrella valve at the bottom of the cylinder prevents the formula from entering the cylinder. Keep these parts clean and replace if worn.

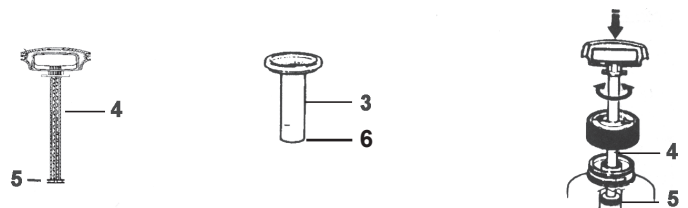

*Disassembly: Unscrew pump assembly from tank. Carefully remove umbrella valve (6) from the bottom of cylinder (3). While holding cylinder firmly with one hand and the handle of the pump piston (4) firmly in the other, with the piston fully inserted in the cylinder, pull back on the piston quickly and forcefully. To re-assemble, place the piston assembly back into cylinder, place heel of hands on opposite sides of the tank cap, while keeping cylinder in place with fingers, tap bottom of cylinder against a flat padded surface. Assembly will lock into place.*





- **Tank Cap:** A small amount of non-water soluble grease\* on tank cap threads and both sides of the gasket eases tightening and loosening.
- **Regular Inspection:** Inspect and replace worn or damaged parts promptly. Pay particular attention to tank cap gasket, pressure relief valve and seal, inflation valve (if fitted), umbrella valve O-rings and seals throughout sprayer. Regular lubrication of O-rings and seals is recommended.

**OPERATING FEATURES:**

Nozzles - Your Solo sprayer is standard with nozzle arrangements which provide a variety of spray patterns.

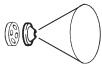
Item	Application	Part #
 Flat spray nozzle	Row treatment	4074263
 Jet stream nozzle	Spot & longer range	4074755

Item	Application	Part #
 Jet stream nozzle and swirl plate = hollow cone	Shrubs and bushes	4074755
 Plastic adjustable	Spot, shrubs & bushes	4900527

**Spray tips should be assembled as follows for desired spray patterns.**

**SPRAY TIP ASSEMBLY**

- 1. Flat spray nozzle
  - 2. Filter
  - 3. Jet cap
  - 4. Swirl plate
  - 5. Nozzle cap
  - 6. Nozzle body
  - 7. Brass adj. nozzle\*
  - 8. Nozzle retaining nut
- \*Brass adjustable nozzle is not a standard item on all Solo sprayers.

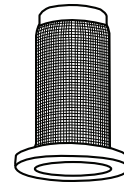

No-drip-check valve replaces # 2 on heavy-duty models

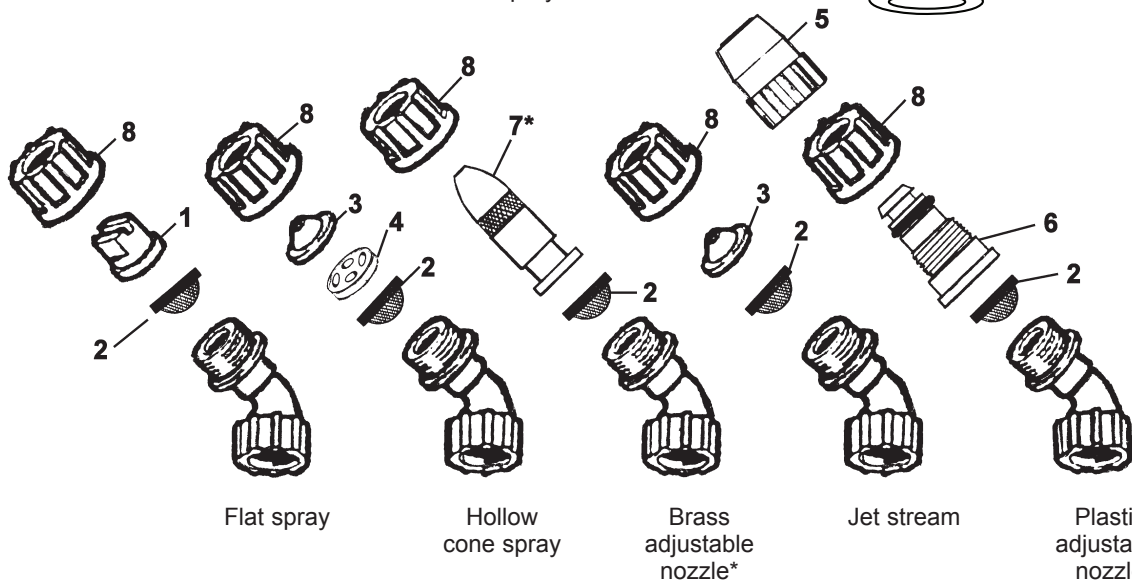

In the best interest of continued technological progress, we reserve the right to change design and configuration of any product without prior or other notice. Therefore, please note that text and illustrations of this manual are not to be considered binding and do not constitute a basis for legal or other claims.

**WILL THE PLASTIC MATERIAL LAST?**

Only high-grade polyethylene is used. The material is chosen for high molecular weight, high-impact strength, and excellent resistance to chemicals and stress. Ultraviolet inhibitors are used in the material to reduce deterioration caused by sunlight.

**HOW HEAVY IS THE UNIT?**

Compression sprayers weigh approximately 5 1/2 lbs.

**CAN I USE WEED KILLER AND INSECTICIDE IN THE SAME SPRAYER?**

In theory you can, if the sprayer is thoroughly cleaned out with a bleach water solution of 1:25. In practice, the use of both types of chemicals in the same unit is not recommended as the risk to plants can be high. Use caution when handling any type of chemicals and when cleaning your sprayer. Do not mix cleaning agents.

**WHAT SPRAY NOZZLE SHOULD I USE?**

A flat spray nozzle is supplied for spraying paths, garden beds, and general area spraying. A cone nozzle is also supplied for spot spraying and for the treatment of bushes and small trees. For spot spraying, simply remove swirl plate from behind nozzle tip. Save the swirl plate for future use. Available as an option is a reflux filter with a built-in check valve (27 00 316) which opens at 5 psi and closes at 4 psi. This virtually eliminates the dripping of fluid still contained in the spray wand. A wide selection of nozzles such as deflector, adjustable, and anti-drift nozzles are available.

**CAN I DO SPOT SPRAYING?**

The shut-off valve on the Solo sprayer is well suited for spot spraying. It's almost effortless! The shut-off valve handle incorporates a clip which holds the valve open for area spraying without tiring the operator's hand. A pressure gauge may be added with increments from 0 to 6 Bar (0-90 psi).

Note: Always wear rubber gloves, safety goggles and appropriate protective clothing when repairing a sprayer. Once a repair is completed, fill the unit with clean water, pressurize, and check for leaks. If the sprayer leaks, DO NOT USE. Repair leaks and re-check.

## SERVICE AND REPAIR SECTION HANDHELD SPRAYER TROUBLE SHOOTING GUIDE

PROBLEM	CAUSE	SOLUTION
<b>Difficulty in moving pump handle</b>	<ul style="list-style-type: none"> <li>dirty cylinder wall</li> <li>O-ring on piston swollen (not cleaned properly)</li> </ul>	<ul style="list-style-type: none"> <li>remove piston, clean, grease and replace</li> <li>replace O-ring, grease</li> </ul>
<b>Low pressure &amp; resistance during pumping</b>	<ul style="list-style-type: none"> <li>No lube on piston/cylinder</li> <li>Chemical in cylinder</li> <li>Damaged O-ring in pressure relief valve</li> <li>worm or damaged O-ring in shut-off valve</li> <li>tank cap not tight</li> </ul>	<ul style="list-style-type: none"> <li>lubricate with heavy grease</li> <li>Replace umbrella valve</li> <li>replace O-ring</li> <li>replace O-ring</li> <li>tighten cap</li> </ul>
<b>Leaks from end of spray wand</b>	<ul style="list-style-type: none"> <li>worn or damaged O-ring in shut-off valve</li> </ul>	<ul style="list-style-type: none"> <li>rebuild shut-off valve</li> </ul>
<b>Leaks from inside cylinder</b>	<ul style="list-style-type: none"> <li>no lube on piston cylinder</li> </ul>	<ul style="list-style-type: none"> <li>lubricate piston, O-ring and cylinder</li> </ul>
<b>Leaks under cap</b>	<ul style="list-style-type: none"> <li>worn or damaged umbrella valve</li> </ul>	<ul style="list-style-type: none"> <li>replace umbrella valve at bottom of cylinder</li> </ul>
<b>Leaks from shut-off valve</b>	<ul style="list-style-type: none"> <li>damaged or missing gasket</li> </ul>	<ul style="list-style-type: none"> <li>replace gasket</li> </ul>
<b>Leaks from hose</b>	<ul style="list-style-type: none"> <li>screw cap not tight</li> </ul>	<ul style="list-style-type: none"> <li>tighten tank cap</li> </ul>
<b>Pressure relief valve sticks</b>	<ul style="list-style-type: none"> <li>worn, damaged or loose fittings, lack of lubrication</li> </ul>	<ul style="list-style-type: none"> <li>tighten fittings and replace worn parts, disassemble and lubricate O-rings</li> </ul>
<b>Air leak - air coming out between halves of the pump support</b>	<ul style="list-style-type: none"> <li>worn, damaged or loose fittings</li> <li>lack of lubrication or contaminated relief valve relief valve assembly</li> <li>tank cap not tight</li> <li>gasket twisted or lacking lubrication</li> <li>tank lip damaged</li> </ul>	<ul style="list-style-type: none"> <li>tighten fittings and the two..... replace worn parts</li> <li>clean and lubricate pressure</li> <li>tighten tank cap</li> <li>straighten gasket and lubricate with grease</li> <li>repair or replace tank</li> </ul>

### ACCESSORIES:

The following accessories are not standard. Order them from your Solo dealer.



**Pressure control gauge (#49 00 322):** displays spraying pressure so operator can maintain desired pressure level.



**2-nozzle spray boom (#49 00 514):** handheld spray boom mounts on end of spray wand (total width 33"; distance between nozzles 24"). Includes 2 flat spray nozzles.



**Pressure limiting valve (#49 00 183):** limits pressure to 5 psi, 10 psi or 15 psi as needed for low pressure applications.

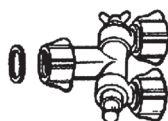

**Double nozzle (#49 00 477):** this is a multi-purpose nozzle that attaches to the end of the spray wand for double row application.



**Brass adjustable spray nozzle (#06 10 410-P):** affords operator a full range of sprays from fine to jet stream.



**Brass spray wand (#49 00 528):** The 2 pcs spray wand is 60" (150 cm) long and replaces the standard spray tube for treating trees up to heights of 16 ft. (5 meters). Additional extension tube available in 20" length (#49 00 513).



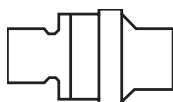

**Drift guard (#49 00 430):** helps control application of formula under breezy conditions.

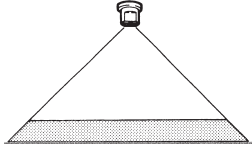
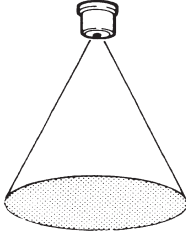
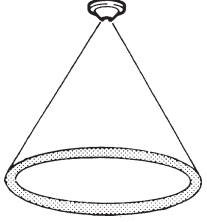

**Controlled Flow Valve (CFValve™):** Provides constant pressure and flow to the spray nozzle and can be used in various applications.

## Nozzle Tip Specifications

Description	Order number	Spray volume		Pressure		Angle	Applications
		1/min	US gal /min	at atm	psi		
Flat Spray nozzle	4074263	0.88 1.25 1.53	.23 .33 .40	1.0 2.0 3.0	15 29 44	120° 120° 120°	area and row treatment 
Flat spray nozzle -brass -plastic with stainless steel insert	0065210 0065132	0.46 0.64 0.78	.12 .17 .21	1.0 2.0 3.0	15 29 44	80° 80° 80°	
Adjustable nozzle -brass -plastic	4900207 4900527	1.53 0.76	.40 .20	2.8 2.8	40 40	Straight stream Hollow cone	tree spraying (adjustable spraying pattern)
Full cone nozzle	0065212					30°-50°	game repellents of high viscosity
Full cone nozzle	0065213					30°-50°	game repellents of low viscosity
Full cone nozzle	0065214						game repellents
Hollow cone nozzle 1 mm orifice	4900209	0.4 0.55	.10 .15	1.0 2.0	15 29		shrubs, bushes 
Hollow cone nozzle 1.4 mm orifice	4900252	0.64 0.91 1.11	.17 .24 .29	1.0 2.0 3.0	15 29 44	50° 65° 65°	
Hollow cone nozzle 1.8 mm orifice	4900322*	0.88 1.25 1.53	.23 .33 .40	1.0 2.0 3.0	15 29 44	55° 70° 72°	
No-drift nozzle AN 0.5	4074383	0.23	.06	1.0	15	90°	
No-drift nozzle AN 1.0	4074385	0.28 0.38 0.46	.07 .10 .12	0.4 0.7 1.0	6 10 15	100° 100° 100°	
No-drift nozzle AN 2.0	4074386	0.55 0.76 0.91	.15 .20 .24	0.4 0.7 1.0	6 10 15	100° 100° 100°	
Non-drift nozzle AN 2.5	4074514	0.72 0.95 1.14	.19 .25 .30	0.4 0.7 1.0	6 10 15	110° 110° 110°	
No-drift nozzle AN 5.0	4074513	1.80 1.90 2.28	.48 .50 .60	0.4 0.7 1.0	6 10 15	120° 120° 120°	
Foam nozzle	4900397	0.76 0.90 1.01 1.10	.20 .23 .26 .29	3.0 4.0 5.0 6.0	45 60 75 90		



# PARTS BREAKDOWN

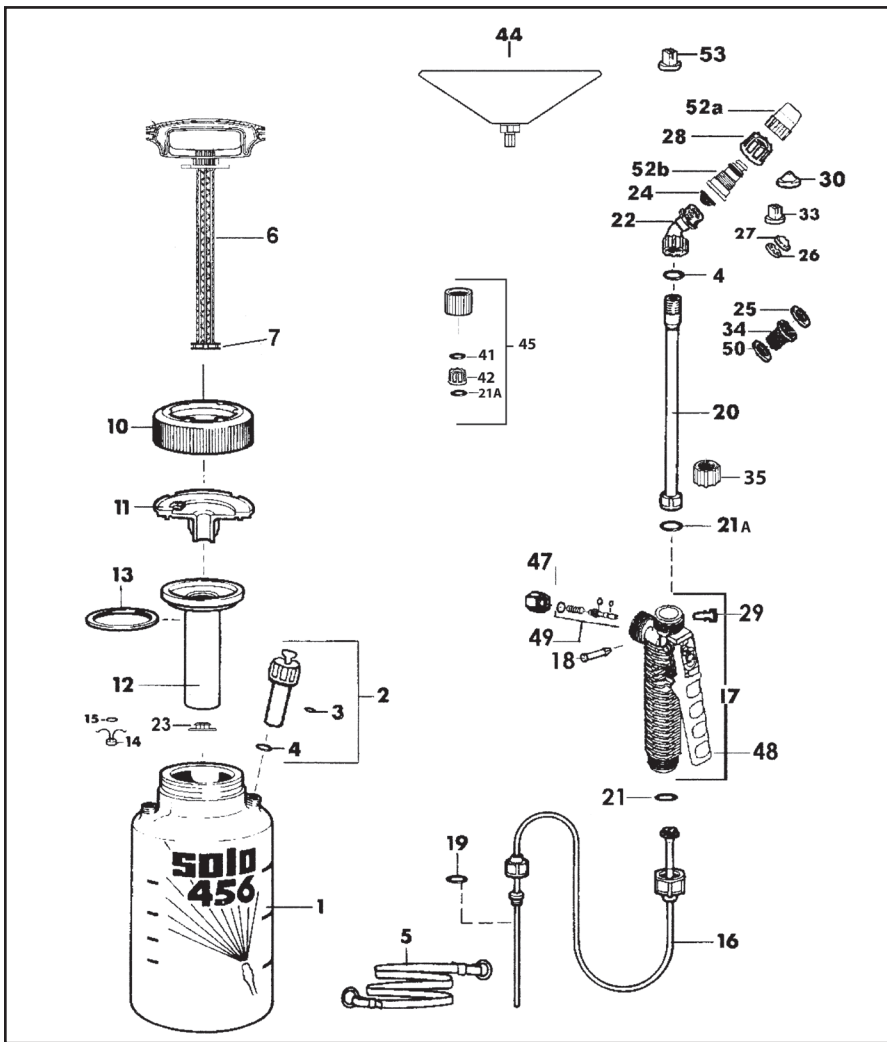

Prices and technical specifications are subject to change without notice.

Pos. No.	Order No.	For Model	Description
1	4071262	456	Tank, 2 gallon
-	4071267	454	Tank, 1 gallon
-	4071263	457	Tank, 3 gallon
2	4800185		Pressure relief valve assy.
3	0062166	*	O-ring
4	0062115	*	O-ring
5	4300245		Carrying strap
6	4073835		Pump piston, solid
7	0062264	*	O-ring
10	4073528		Tank cap, red
-	4073111	HD	Tank cap, black
11	4074387		Cylinder support (need 2)
12	4073834		Cylinder
-	4073834		Cylinder (use with 0094308)
13	4061345	*	Gasket
14	4074656	*	Valve cone
15	0062165	*	O-ring
16	4900515	***	Pressure hose, assy.
17	4800170		Shut-off valve, assy.
18	4074295		Pin retaining
19	0062144	*	O-ring
20	4900230		Wand, assy. (inc. 35 & 21A)
21	4900645	456SW	Stainless Wand
21A	0062271		O-ring
22	0062258		O-ring
23	0094308	*	Elbow
24	4074283		Umbrella valve
25	0062106		Filter
26	4074756		O-ring
27	4074755		Swirl plate
28	4074148		Jet cap tip
29	4074329		Retaining nut
33	4074263		Lock clip
47	4074336		Flat spray nozzle
48	4074335		Retaining nut
49	0610402-K		Lever
52	4900527		Shut-off valve repair kit
	4900207	456SW	Plastic adj. nozzle (incl. a & b)
			Brass adj. nozzle

## Accessories

Pos. No.	Order No.	For Model	Description
-	4900405-K		Pump repair kit
25	0062106	HD	O-ring
30	4074726	**	Hollow cone nozzle
34	2700316	HD	No drip check valve
35	4074337		Retaining nut
41	0062249		O-ring
42	4074338		Retaining nut
43	4065189		Pressure gauge guard
44	4900430		Drift guard
45	4900622		Pressure gauge assy.
50	0062115	HD	O-ring
53	0065210	HD	Brass flat spray nozzle

\* Pump repair kit \*\* Organic liquid spray kit  
 \*\*\*Cut pick-up tube to fit for models 454 and 456

## SOLO LIMITED WARRANTY

**Solo Incorporated guarantees the original purchaser of Solo equipment, that any failure of Solo manufactured parts due to defects in material and workmanship occurring during the applicable warranty period will be repaired or replaced without charge for parts or labor, except for those items not covered by warranty.**

**CONSUMER LIMITED WARRANTY:** Solo equipment purchased for consumer use is covered by this Limited Warranty for a period of FIVE (5) YEARS.

**COMMERCIAL LIMITED WARRANTY:** Solo equipment purchased for commercial use is covered by this Limited Warranty for a period of ONE (1) YEAR.









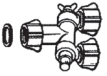

**OPERATOR'S OBLIGATION AND RESPONSIBILITY:** proof of purchase must be provided by the owner in order to obtain warranty service. Should any failure covered by this Limited Warranty occur, deliver or ship the Solo products or parts to an authorized Solo service center. Freight, packing and insurance costs, if any, will be borne by the owner. Follow normal maintenance service to include applicable lubrication, operation and storage of the product as explained in the owner's manual.

**ITEMS NOT COVERED BY WARRANTY:** provisions of the Limited Warranty will not apply to the following: Any indirect or consequential damages that may result from the failure or malfunction of the Solo product. Normal service requirements arising during the warranty period, such as cleaning, normal wear, lubrication, filter, spray tips, etc. Normal service work over and above the repair or replacement of defective parts. Any failure that results from an accident, customer abuse, normal wear, neglect or failure to operate the product in accordance with the instructions provided in the operator's manual or provided with the product. When an alteration or modification has been performed on a Solo product, Solo is responsible only for products as originally furnished by Solo, provided the alterations or modifications do not adversely affect the product's operation, performance or durability. Parts or accessories that are incomplete with the product are not approved by Solo.

Full disclosure of Solo's Limited Warranty is available from your local Solo dealer or Solo Incorporated, 5100 Chestnut Avenue, Newport News, Virginia 23605.

This Limited Warranty gives you specific legal rights and you may also have other rights which vary from state to state.

Order parts and accessories from your Solo dealer. If there is no local dealer, use this form to order from Solo.

Item Names/Description	Part No.	Retail Price	Qty.	Total
<b>Nozzles</b>				
 <b>Flat spray nozzle</b> - surface area & row treatment	40 74 263	2.00		
<b>Jet cap</b>	40 74 755	1.50		
<b>Swirl plate</b>	40 74 756	1.50		
<b>Filter</b> - standard	40 74 283	2.56		
<b>Sprayer elbow and nozzle assortment</b>	06 10 408-P	14.95		
<b>No-drift wide angle flat nozzles</b> - .60 GPM	40 74 513	2.50		
mainly for spraying herbicides at low pressure. .30 GPM	40 74 514	2.50		
At 15 psi they deliver: .24 GPM	40 74 386	2.50		
.12 GPM	40 74 385	2.50		
 <b>Elbow nozzle assembly</b>	49 00 258N	6.35		
<b>Double spray nozzle</b> - for double row application spraying in two directions simultaneously.	49 00 477	24.95		
<b>Brass adjustable spray nozzle kit</b> - with O-ring and screw cap for tree spraying (from fine misting to a jet stream).	06 10 410-P	8.75		
 <b>Brass adjustable spray nozzle</b> (same nozzle as kit above)	49 00 207	6.25		
<b>Plastic adjustable nozzle</b>	49 00 527	4.25		
<b>Hollow cone nozzles</b> - for shrubs & bushes: 1.4 mm	49 00 252	2.85		
1.8 mm	49 00 322	2.85		
<b>Jet stream nozzle</b>	40 74 758	1.50		
 <b>Foam spray nozzle</b> - for low drift & water saving application of herbicides which tend to foam.	49 00 397	9.95		
<b>No drip check valve</b> - prevents spray tip from leaking when not in use.	27 00 316	4.95		
<b>Nozzle assortment</b> - includes flat, hollow cone, no drift, and plastic adjustable nozzles.	06 10 456-P	12.95		
<b>Extension tubes and spray wands</b>				
6" bendable spray wand	49 00 450	18.95		
20" spray wand	49 00 230	9.95		
20" extension tube	49 00 513	13.50		
21" stainless steel wand	49 00 645-P	11.95		
20" brass spray wand	49 00 421	12.95		
27" spray wand	49 00 319	13.50		
40" brass telescoping wand	49 00 478	29.95		
48" carbon fiber wand	49 00 449	35.95		
60" brass spray wand	49 00 528	29.95		
4' to 8' Carbon Fiber Wand	49 00 445	69.95		
<b>Note:</b> extension tubes attach to wands to extend length. Spray wands attach to shut-off valve only.				
<b>Spray booms</b>				
 <b>Spray booms</b> - spray 2 or 4 rows at once with: <b>2-nozzle spray boom</b> - handheld (total width 33") distance between nozzles 24". Includes 2 flat spray nozzles	49 00 514	31.95		
<b>4-nozzle spray boom</b> - mounts on rear of sprayer (total width 49 3/4"; distance between nozzles 16"). Includes 4 hollow cone nozzles.	49 00 298	79.95		
<b>Specialty items</b>				
Solo Superior grease	9850	2.95		
 <b>Pressure gauge kits</b> - indicates spray pressure. Use with shut-off valve 4800170. Fits all models.	49 00 622	17.75		
 <b>Pressure limiting valve</b> - for no-drift spraying of herbicides. Helps operator maintain pressure below 15 psi. Interchangeable springs are color coded for 5, 10 and 15 psi.	49 00 183	18.95		
 <b>Drift guard</b> - complete control for herbicide applications in berry, flower, vegetable, cotton & other applications.	49 00 430	16.95		
 <b>Shut-off valve</b>	48 00 170	14.75		
 <b>Shut-off valve, wand &amp; elbow nozzle assy.</b>	49 00 170N	19.95		
 <b>Pump repair kit</b> - contains original equipment O-rings to renew all sealing surfaces on 454, 456, 457 sprayers	49 00 405-K	5.95		
<b>Shut-off and pump repair kit</b>	0610411-K	9.95		
<b>Sprayer service video</b>	998SPVID	9.95		
<b>454/456/457 Operator's Manual, Spare Parts List</b>	US9456702	NC		NC
Prices and technical specifications are subject to change without notice.	<b>SUBTOTAL</b>			<b>\$</b>

# PARTS BREAKDOWN

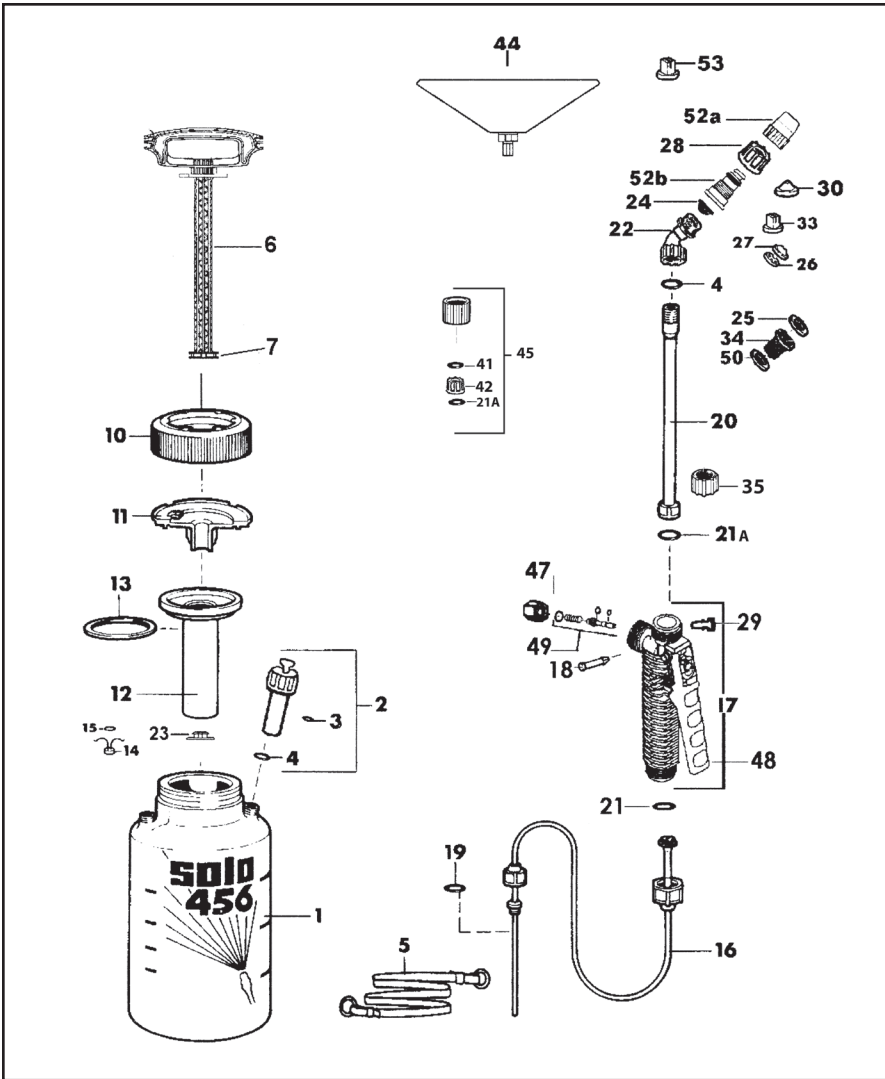

Pos. No.	Order No.	For Model	Description
1	4071262	456	Tank, 2 gallon
-	4071267	454	Tank, 1 gallon
-	4071263	457	Tank, 3 gallon
2	4800185	*	Pressure relief valve assy.
3	0062166	*	O-ring
4	0062115	*	O-ring
5	4300245	*	Carrying strap
6	4073835	*	Pump piston, solid
7	0062264	*	O-ring
10	4073528		Tank cap, red
-	4073111	HD	Tank cap, black
11	4074387		Cylinder support (need 2)
12	4073834		Cylinder
13	4073834		Cylinder (use with 0094308)
-	4061345	*	Gasket
14	4074656	*	Valve cone
15	0062165	*	O-ring
16	4900515	***	Pressure hose, assy.
17	4800170		Shut-off valve, assy.
18	4074295	*	Pin retaining
19	0062144	*	O-ring
20	4900230		Wand, assy. (inc. 35 & 21A)
21	4900645	456SW	Stainless Wand
21A	0062271		O-ring
21A	0062258		O-ring
22	4074527	*	Elbow
23	0094308	*	Umbrella valve
24	4074283		Filter
25	0062106		O-ring
26	4074756		Swirl plate
27	4074755		Jet cap tip
28	4074148		Retaining nut
29	4074329		Lock clip
33	4074263		Flat spray nozzle
47	4074336		Retaining nut
48	4074335		Lever
49	0610402-K		Shut-off valve repair kit
52	4900527		Plastic adj. nozzle (incl. a & b)
	4900207	456SW	Brass adj. nozzle

## Accessories

Pos. No.	Order No.	For Model	Description
-	4900405-K		Pump repair kit
25	0062106	HD	O-ring
30	4074726	HD	Hollow cone nozzle
34	2700316	HD	No drip check valve
35	4074337		Retaining nut
41	0062249		O-ring
42	4074338		Retaining nut
43	4065189		Pressure gauge guard
44	4900430		Drift guard
45	4900622		Pressure gauge assy.
50	0062115	HD	O-ring
53	0065210	HD	Brass flat spray nozzle

\* Pump repair kit

\*\*\*Cut pick-up tube to fit for models 454 and 456

Prices and technical specifications are subject to change without notice.

Mail or Fax to: Solo • 5100 Chestnut Avenue  
Newport News, VA 23605 • Phone: (757) 245-4228 • Fax: (757) 245-0800  
Order Online: [www.solousa.com](http://www.solousa.com) E-mail: [solo@solousa.com](mailto:solo@solousa.com)

Please do not send cash with this order. Make check or money order payable to Solo Incorporated. You may request C.O.D. shipment. Please call for current C.O.D. charges.

Form of Payment:



- Credit Card
- Check or Money Order
- C.O.D.

Credit Card Number \_\_\_\_\_

Expiration Date \_\_\_\_\_

Signature and Phone Number \_\_\_\_\_

We cannot process your credit card purchase without a signature and expiration date.

PLEASE PRINT:

Name \_\_\_\_\_

Address \_\_\_\_\_

City \_\_\_\_\_ State \_\_\_\_\_ Zip \_\_\_\_\_

Total from Previous Page	\$
VA & NC residents add applicable sales tax	\$
Shipping	\$ 7.95
Grand Total	\$
Please allow 1-2 weeks for delivery	

# SOLO®

**5100 Chestnut Avenue  
Newport News, VA 23605**